

**Autumn Racing Friday**  
**Race 1: Thoroughbred Industry Employee Awards Amateur Jockeys'**  
**Handicap - 6F 220Y**  
**06 October 2023 - 14:13**



Track Rating: Good, Weather: Fine, Rail Position: True

| Distance To Go |     |                         |         | 6fur                 | 5fur                 | 4fur                 | 3fur                 | 2fur                 | 1fur                 | Last 3fur    |              |                           |      |
|----------------|-----|-------------------------|---------|----------------------|----------------------|----------------------|----------------------|----------------------|----------------------|--------------|--------------|---------------------------|------|
| Field Times    |     |                         |         | 0:15.12<br>(0:15.12) | 0:26.74<br>(0:11.62) | 0:38.40<br>(0:11.66) | 0:49.91<br>(0:11.51) | 1:01.78<br>(0:11.87) | 1:14.92<br>(0:13.14) | 0:39.06      |              |                           |      |
| Rank           | Nr. | Horse                   | Barrier | Top Speed<br>[mi/h]  | Fastest<br>Section   |                      |                      |                      |                      |              |              | Distance<br>Travelled [m] |      |
| 1              | 14  | <b>ALAZWAR</b>          | 11      | 39.5                 | 0:11.65              | 0:15.20 [3]          | 0:26.90 [3]          | 0:38.55 [3]          | 0:50.25 [2]          | 1:01.96 [2]  | 1:14.92 [1]  | 0:38.72                   | 1408 |
|                |     | Miss Brodie Hampson     |         | 4fur                 | 4fur                 | (0:15.20)            | (0:11.70)            | (0:11.65)            | (0:11.70)            | (0:11.71)    | (0:12.96)    |                           |      |
| 2              | 9   | <b>HIERONYMUS</b>       | 13      | 39.7                 | 0:11.51              | 0:15.16 [2]          | 0:26.74 [1]          | 0:38.40 [1]          | 0:49.91 [1]          | 1:01.78 [1]  | 1:15.05 [2]  | 0:39.65                   | 1408 |
|                |     | Mr S Walker             |         | 4fur                 | 3fur                 | (0:15.16)            | (0:11.58)            | (0:11.66)            | (0:11.51)            | (0:11.87)    | (0:13.27)    |                           |      |
| 3              | 7   | <b>TWO TEMPTING</b>     | 14      | 39.3                 | 0:11.64              | 0:15.46 [6]          | 0:27.21 [5]          | 0:38.85 [4]          | 0:50.60 [4]          | 1:02.44 [3]  | 1:15.78 [3]  | 0:39.40                   | 1408 |
|                |     | Mr J Harding            |         | 4fur                 | 4fur                 | (0:15.46)            | (0:11.75)            | (0:11.64)            | (0:11.75)            | (0:11.84)    | (0:13.34)    |                           |      |
| 4              | 12  | <b>CONQUISTADOR</b>     | 9       | 39.0                 | 0:11.69              | 0:15.79 [11]         | 0:27.48 [11]         | 0:39.24 [10]         | 0:50.96 [8]          | 1:02.77 [5]  | 1:15.95 [4]  | 0:39.36                   | 1407 |
|                |     | Mr Jack Callan          |         | 2fur                 | 5fur                 | (0:15.79)            | (0:11.69)            | (0:11.76)            | (0:11.72)            | (0:11.81)    | (0:13.18)    |                           |      |
| 5              | 3   | <b>FINAL WATCH</b>      | 4       | 39.1                 | 0:11.76              | 0:15.54 [8]          | 0:27.35 [7]          | 0:39.12 [6]          | 0:50.88 [5]          | 1:02.81 [6]  | 1:16.25 [6]  | 0:39.63                   | 1409 |
|                |     | Mr R Birkett            |         | 2fur                 | 3fur                 | (0:15.54)            | (0:11.81)            | (0:11.77)            | (0:11.76)            | (0:11.93)    | (0:13.44)    |                           |      |
| 6              | 13  | <b>FLYING SECRET</b>    | 6       | 38.6                 | 0:11.81              | 0:15.48 [7]          | 0:27.38 [8]          | 0:39.19 [9]          | 0:51.08 [9]          | 1:03.06 [10] | 1:16.16 [5]  | 0:39.57                   | 1409 |
|                |     | Mr Jack Nicholls        |         | 4fur                 | 4fur                 | (0:15.48)            | (0:11.90)            | (0:11.81)            | (0:11.89)            | (0:11.98)    | (0:13.10)    |                           |      |
| 7              | 1   | <b>PAWS FOR THOUGHT</b> | 5       | 38.6                 | 0:11.84              | 0:15.26 [4]          | 0:27.20 [4]          | 0:39.04 [5]          | 0:50.92 [7]          | 1:02.91 [8]  | 1:16.34 [7]  | 0:40.11                   | 1408 |
|                |     | Miss Lucy Turner        |         | 2fur                 | 4fur                 | (0:15.26)            | (0:11.94)            | (0:11.84)            | (0:11.88)            | (0:11.99)    | (0:13.43)    |                           |      |
| 8              | 6   | <b>KIMNKATE</b>         | 3       | 39.2                 | 0:11.62              | 0:15.78 [10]         | 0:27.40 [9]          | 0:39.12 [7]          | 0:50.90 [6]          | 1:02.89 [7]  | 1:16.48 [8]  | 0:40.53                   | 1408 |
|                |     | Miss Taryn Langley      |         | 4fur                 | 5fur                 | (0:15.78)            | (0:11.62)            | (0:11.72)            | (0:11.78)            | (0:11.99)    | (0:13.59)    |                           |      |
| 9              | 8   | <b>FARO DE SAN JUAN</b> | 7       | 40.3                 | 0:11.34              | 0:16.28 [12]         | 0:27.62 [12]         | 0:39.37 [11]         | 0:51.15 [10]         | 1:02.99 [9]  | 1:16.55 [9]  | 0:40.21                   | 1409 |
|                |     | Mr Fletcher Yarham      |         | 5fur                 | 5fur                 | (0:16.28)            | (0:11.34)            | (0:11.75)            | (0:11.78)            | (0:11.84)    | (0:13.56)    |                           |      |
| 10             | 11  | <b>WYVERN</b>           | 2       | 38.4                 | 0:11.88              | 0:15.57 [9]          | 0:27.45 [10]         | 0:39.45 [12]         | 0:51.43 [12]         | 1:03.52 [11] | 1:17.07 [10] | 0:40.37                   | 1409 |
|                |     | Mr Frederick Daly       |         | 2fur                 | 5fur                 | (0:15.57)            | (0:11.88)            | (0:12.00)            | (0:11.98)            | (0:12.09)    | (0:13.55)    |                           |      |

[ ] Ranking at each section and finish  
 -:-:- No data available at this section  
 NA No data available

SCN Saddle cloth number  
 DNF Did not finish  
 DNT Did not track

data processed by



**Autumn Racing Friday**  
**Race 1: Thoroughbred Industry Employee Awards Amateur Jockeys'**  
**Handicap - 6F 220Y**  
**06 October 2023 - 14:13**



Track Rating: Good, Weather: Fine, Rail Position: True

| Distance To Go |     | 6fur                  | 5fur                 | 4fur                 | 3fur                 | 2fur                      | 1fur                 | Last 3fur   |              |              |              |         |      |
|----------------|-----|-----------------------|----------------------|----------------------|----------------------|---------------------------|----------------------|-------------|--------------|--------------|--------------|---------|------|
| Field Times    |     | 0:15.12<br>(0:15.12)  | 0:26.74<br>(0:11.62) | 0:38.40<br>(0:11.66) | 0:49.91<br>(0:11.51) | 1:01.78<br>(0:11.87)      | 1:14.92<br>(0:13.14) | 0:39.06     |              |              |              |         |      |
| Rank           | Nr. | Horse                 | Barrier              | Top Speed<br>[mi/h]  | Fastest<br>Section   | Distance<br>Travelled [m] |                      |             |              |              |              |         |      |
| 11             | 4   | <b>CRYSTAL CASQUE</b> | 12                   | 38.4                 | 0:11.91              | 0:15.33 [5]               | 0:27.24 [6]          | 0:39.18 [8] | 0:51.21 [11] | 1:03.66 [12] | 1:17.43 [12] | 0:40.82 | 1408 |
|                |     | Mrs Jo Supple         |                      | 4fur                 | 5fur                 | (0:15.33)                 | (0:11.91)            | (0:11.94)   | (0:12.03)    | (0:12.45)    | (0:13.77)    |         |      |
| 12             | 2   | <b>AMBER ISLAND</b>   | 1                    | 39.1                 | 0:11.68              | 0:15.12 [1]               | 0:26.86 [2]          | 0:38.54 [2] | 0:50.48 [3]  | 1:02.74 [4]  | 1:17.08 [11] | 0:43.99 | 1408 |
|                |     | Mr Paul Kavanagh      |                      | 4fur                 | 4fur                 | (0:15.12)                 | (0:11.74)            | (0:11.68)   | (0:11.94)    | (0:12.26)    | (0:14.34)    |         |      |

**Autumn Racing Friday**  
**Race 1: Thoroughbred Industry Employee Awards Amateur Jockeys'**  
**Handicap - 6F 220Y**  
**06 October 2023 - 14:13**



Track Rating: Good, Weather: Fine, Rail Position: True

| Distance To Go |     |                         |         | Finish           |                 |                      |         | Last 3fur |                        |      |
|----------------|-----|-------------------------|---------|------------------|-----------------|----------------------|---------|-----------|------------------------|------|
| Field Times    |     |                         |         | 1:28.97          |                 |                      |         | 0:39.06   |                        |      |
|                |     |                         |         | (0:14.05)        |                 |                      |         |           |                        |      |
| Rank           | Nr. | Horse                   | Barrier | Top Speed [mi/h] | Fastest Section | Official Finish Time |         |           | Distance Travelled [m] |      |
| 1              | 14  | <b>ALAZWAR</b>          | 11      | 39.5             | 0:11.65         | 1:28.97              | 1:28.85 |           | 0:38.72                | 1408 |
|                |     | Miss Brodie Hampson     |         | 4fur             | 4fur            | (0:14.05)            |         |           |                        |      |
| 2              | 9   | <b>HIERONYMUS</b>       | 13      | 39.7             | 0:11.51         | 1:29.56              | 1:29.34 |           | 0:39.65                | 1408 |
|                |     | Mr S Walker             |         | 4fur             | 3fur            | (0:14.51)            |         |           |                        |      |
| 3              | 7   | <b>TWO TEMPTING</b>     | 14      | 39.3             | 0:11.64         | 1:30.00              | 1:29.79 |           | 0:39.40                | 1408 |
|                |     | Mr J Harding            |         | 4fur             | 4fur            | (0:14.22)            |         |           |                        |      |
| 4              | 12  | <b>CONQUISTADOR</b>     | 9       | 39.0             | 0:11.69         | 1:30.32              | 1:30.16 |           | 0:39.36                | 1407 |
|                |     | Mr Jack Callan          |         | 2fur             | 5fur            | (0:14.37)            |         |           |                        |      |
| 5              | 3   | <b>FINAL WATCH</b>      | 4       | 39.1             | 0:11.76         | 1:30.51              | 1:30.46 |           | 0:39.63                | 1409 |
|                |     | Mr R Birkett            |         | 2fur             | 3fur            | (0:14.26)            |         |           |                        |      |
| 6              | 13  | <b>FLYING SECRET</b>    | 6       | 38.6             | 0:11.81         | 1:30.65              | 1:30.47 |           | 0:39.57                | 1409 |
|                |     | Mr Jack Nicholls        |         | 4fur             | 4fur            | (0:14.49)            |         |           |                        |      |
| 7              | 1   | <b>PAWS FOR THOUGHT</b> | 5       | 38.6             | 0:11.84         | 1:31.03              | 1:30.68 |           | 0:40.11                | 1408 |
|                |     | Miss Lucy Turner        |         | 2fur             | 4fur            | (0:14.69)            |         |           |                        |      |
| 8              | 6   | <b>KIMNKATE</b>         | 3       | 39.2             | 0:11.62         | 1:31.43              | 1:31.26 |           | 0:40.53                | 1408 |
|                |     | Miss Taryn Langley      |         | 4fur             | 5fur            | (0:14.95)            |         |           |                        |      |
| 9              | 8   | <b>FARO DE SAN JUAN</b> | 7       | 40.3             | 0:11.34         | 1:31.36              | 1:31.39 |           | 0:40.21                | 1409 |
|                |     | Mr Fletcher Yarham      |         | 5fur             | 5fur            | (0:14.81)            |         |           |                        |      |
| 10             | 11  | <b>WYVERN</b>           | 2       | 38.4             | 0:11.88         | 1:31.80              | 1:31.71 |           | 0:40.37                | 1409 |
|                |     | Mr Frederick Daly       |         | 2fur             | 5fur            | (0:14.73)            |         |           |                        |      |

[ ] Ranking at each section and finish  
 -:-:- No data available at this section  
 NA No data available

SCN Saddle cloth number  
 DNF Did not finish  
 DNT Did not track

data processed by



**Autumn Racing Friday**  
**Race 1: Thoroughbred Industry Employee Awards Amateur Jockeys'**  
**Handicap - 6F 220Y**  
**06 October 2023 - 14:13**



Track Rating: Good, Weather: Fine, Rail Position: True

| Distance To Go |     |                       |         | Finish           |                 |                      |         | Last 3fur |                        |
|----------------|-----|-----------------------|---------|------------------|-----------------|----------------------|---------|-----------|------------------------|
| Field Times    |     |                       |         | 1:28.97          |                 |                      |         | 0:39.06   |                        |
|                |     |                       |         | (0:14.05)        |                 |                      |         |           |                        |
| Rank           | Nr. | Horse                 | Barrier | Top Speed [mi/h] | Fastest Section | Official Finish Time |         |           | Distance Travelled [m] |
| 11             | 4   | <b>CRYSTAL CASQUE</b> | 12      | 38.4             | 0:11.91         | 1:32.03              | 1:31.85 |           | 1408                   |
|                |     | Mrs Jo Supple         |         | 4fur             | 5fur            | (0:14.60)            |         | 0:40.82   |                        |
| 12             | 2   | <b>AMBER ISLAND</b>   | 1       | 39.1             | 0:11.68         | 1:34.47              | 1:34.28 |           | 1408                   |
|                |     | Mr Paul Kavanagh      |         | 4fur             | 4fur            | (0:17.39)            |         | 0:43.99   |                        |

- [ ] Ranking at each section and finish
- :--:- No data available at this section
- NA No data available
- SCN Saddle cloth number
- DNF Did not finish
- DNT Did not track

|                                |                |
|--------------------------------|----------------|
| Horse Name                     | Alazwar        |
| Final Rank                     | 1              |
| Fastest Section Time (Section) | 0:11.65 (4fur) |
| Top Speed [mi/h] (Section)     | 39.5 (4fur)    |
| Race State                     | Finished       |

Autumn Racing Friday  
Race 1: Thoroughbred Industry Employee Awards Amateur  
Jockeys' Handicap - 6F 220Y



06 October 2023 - 14:13

Track Rating: Good, Weather: Fine, Rail Position: True

| Distance To Go         | 6fur                     | 5fur                     | 4fur                     | 3fur                     | 2fur                     | 1fur                     | Finish               |  |  |  |  |  |  |
|------------------------|--------------------------|--------------------------|--------------------------|--------------------------|--------------------------|--------------------------|----------------------|--|--|--|--|--|--|
| Section Times          | 0:15.20 [3]<br>(0:15.20) | 0:26.90 [3]<br>(0:11.70) | 0:38.55 [3]<br>(0:11.65) | 0:50.25 [2]<br>(0:11.70) | 1:01.96 [2]<br>(0:11.71) | 1:14.92 [1]<br>(0:12.96) | 1:28.97<br>(0:14.05) |  |  |  |  |  |  |
| Average Speed [mi/h]   | 29.8                     | 38.4                     | 38.7                     | 38.5                     | 38.2                     | 35.0                     | 31.6                 |  |  |  |  |  |  |
| Top Speed [mi/h]       | 36.1                     | 39.0                     | 39.5                     | 39.0                     | 39.4                     | 38.7                     | 34.9                 |  |  |  |  |  |  |
| Avg. Dist. to Rail [m] | 27.6                     | 29.3                     | 28.9                     | 28.4                     | 28.3                     | 28.3                     | 29.4                 |  |  |  |  |  |  |
| Avg. Stride Freq. [Hz] | 2.2                      | 2.3                      | 2.3                      | 2.3                      | 2.3                      | 2.3                      | 2.2                  |  |  |  |  |  |  |
| Avg. Stride Length [m] | 6.2                      | 7.3                      | 7.5                      | 7.5                      | 7.3                      | 6.9                      | 6.5                  |  |  |  |  |  |  |

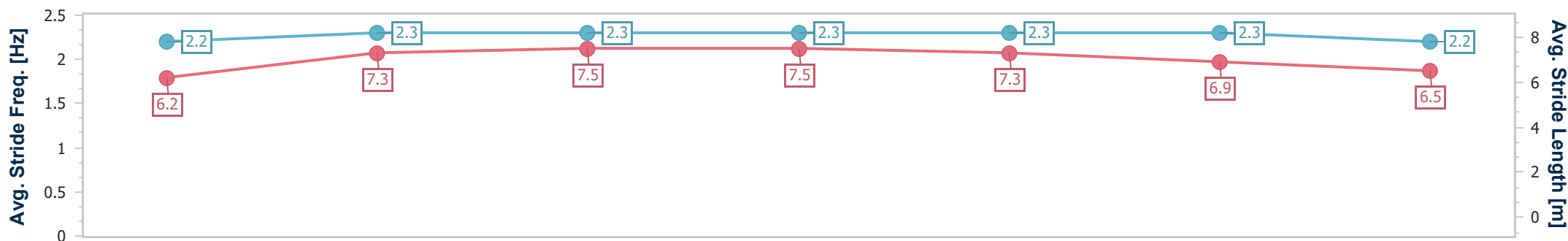
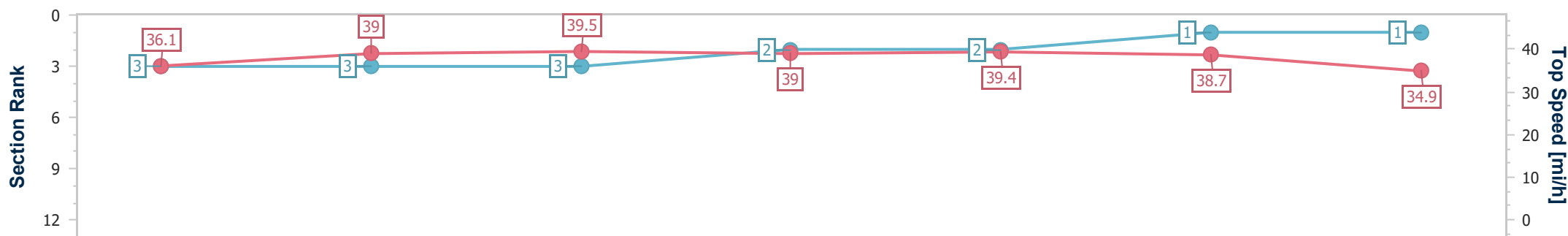

- [ ] Ranking at each section and finish
- .-.- No data available at this section
- NA No data available

|                                |                |
|--------------------------------|----------------|
| Horse Name                     | Hieronymus     |
| Final Rank                     | 2              |
| Fastest Section Time (Section) | 0:11.51 (3fur) |
| Top Speed [mi/h] (Section)     | 39.7 (4fur)    |
| Race State                     | Finished       |

Autumn Racing Friday  
Race 1: Thoroughbred Industry Employee Awards Amateur  
Jockeys' Handicap - 6F 220Y



06 October 2023 - 14:13

Track Rating: Good, Weather: Fine, Rail Position: True

| Distance To Go         | 6fur                     | 5fur                     | 4fur                     | 3fur                     | 2fur                     | 1fur                     | Finish               |  |  |  |  |  |  |
|------------------------|--------------------------|--------------------------|--------------------------|--------------------------|--------------------------|--------------------------|----------------------|--|--|--|--|--|--|
| Section Times          | 0:15.16 [2]<br>(0:15.16) | 0:26.74 [1]<br>(0:11.58) | 0:38.40 [1]<br>(0:11.66) | 0:49.91 [1]<br>(0:11.51) | 1:01.78 [1]<br>(0:11.87) | 1:15.05 [2]<br>(0:13.27) | 1:29.56<br>(0:14.51) |  |  |  |  |  |  |
| Average Speed [mi/h]   | 29.9                     | 38.8                     | 38.7                     | 39.1                     | 37.8                     | 34.0                     | 30.6                 |  |  |  |  |  |  |
| Top Speed [mi/h]       | 35.9                     | 39.4                     | 39.7                     | 39.6                     | 39.7                     | 38.0                     | 33.8                 |  |  |  |  |  |  |
| Avg. Dist. to Rail [m] | 29.7                     | 30.0                     | 30.0                     | 29.5                     | 29.2                     | 29.0                     | 28.8                 |  |  |  |  |  |  |
| Avg. Stride Freq. [Hz] | 2.2                      | 2.4                      | 2.4                      | 2.4                      | 2.4                      | 2.3                      | 2.2                  |  |  |  |  |  |  |
| Avg. Stride Length [m] | 6.0                      | 7.3                      | 7.3                      | 7.3                      | 7.1                      | 6.6                      | 6.3                  |  |  |  |  |  |  |

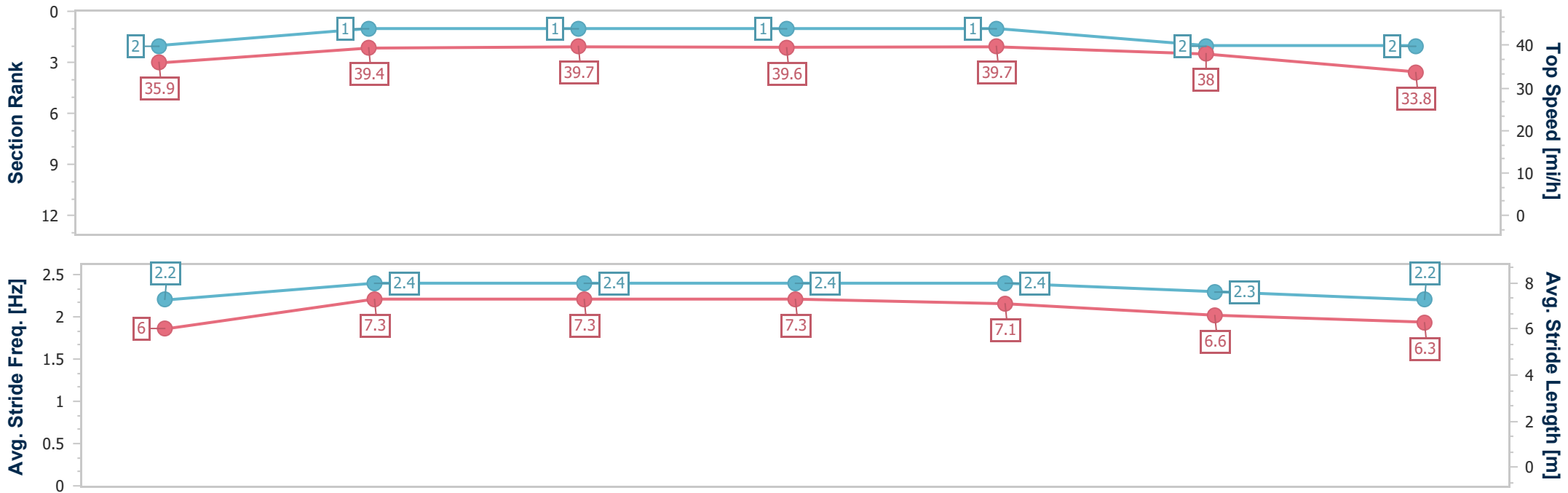

- [ ] Ranking at each section and finish
- .-.-.- No data available at this section
- NA No data available

|                                |                |
|--------------------------------|----------------|
| Horse Name                     | Two Tempting   |
| Final Rank                     | 3              |
| Fastest Section Time (Section) | 0:11.64 (4fur) |
| Top Speed [mi/h] (Section)     | 39.3 (4fur)    |
| Race State                     | Finished       |

Autumn Racing Friday  
Race 1: Thoroughbred Industry Employee Awards Amateur Jockeys' Handicap - 6F 220Y



06 October 2023 - 14:13

Track Rating: Good, Weather: Fine, Rail Position: True

| Distance To Go         | 6fur                     | 5fur                     | 4fur                     | 3fur                     | 2fur                     | 1fur                     | Finish               |
|------------------------|--------------------------|--------------------------|--------------------------|--------------------------|--------------------------|--------------------------|----------------------|
| Section Times          | 0:15.46 [6]<br>(0:15.46) | 0:27.21 [5]<br>(0:11.75) | 0:38.85 [4]<br>(0:11.64) | 0:50.60 [4]<br>(0:11.75) | 1:02.44 [3]<br>(0:11.84) | 1:15.78 [3]<br>(0:13.34) | 1:30.00<br>(0:14.22) |
| Average Speed [mi/h]   | 29.3                     | 38.3                     | 38.7                     | 38.2                     | 38.0                     | 33.8                     | 31.5                 |
| Top Speed [mi/h]       | 36.0                     | 38.9                     | 39.3                     | 39.1                     | 39.1                     | 38.3                     | 33.6                 |
| Avg. Dist. to Rail [m] | 30.0                     | 29.5                     | 27.6                     | 27.0                     | 26.7                     | 27.4                     | 29.9                 |
| Avg. Stride Freq. [Hz] | 2.3                      | 2.4                      | 2.5                      | 2.5                      | 2.5                      | 2.4                      | 2.3                  |
| Avg. Stride Length [m] | 5.8                      | 7.0                      | 7.1                      | 6.9                      | 6.8                      | 6.3                      | 6.2                  |

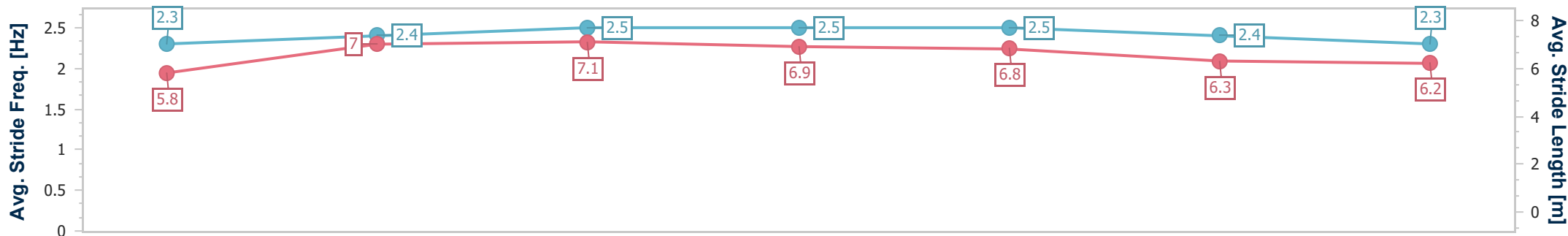
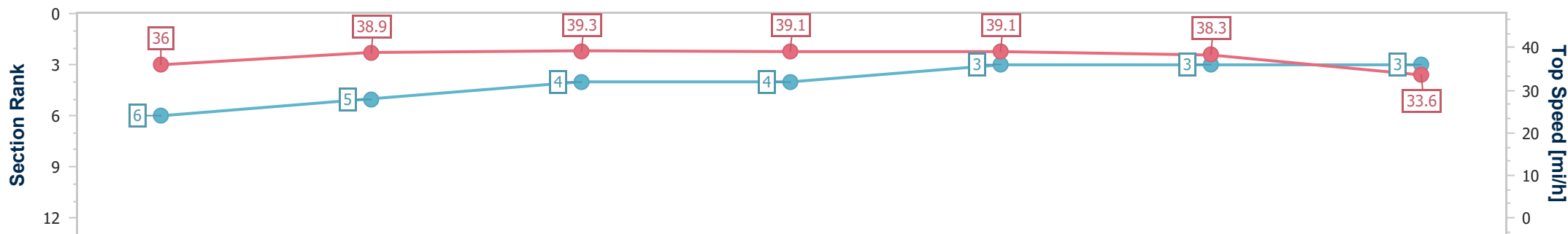

- [ ] Ranking at each section and finish
- .-.- No data available at this section
- NA No data available

|                                |                |
|--------------------------------|----------------|
| Horse Name                     | Conquistador   |
| Final Rank                     | 4              |
| Fastest Section Time (Section) | 0:11.69 (5fur) |
| Top Speed [mi/h] (Section)     | 39.0 (2fur)    |
| Race State                     | Finished       |

Autumn Racing Friday  
Race 1: Thoroughbred Industry Employee Awards Amateur  
Jockeys' Handicap - 6F 220Y



06 October 2023 - 14:13

Track Rating: Good, Weather: Fine, Rail Position: True

| Distance To Go         | 6fur                      | 5fur                      | 4fur                      | 3fur                     | 2fur                     | 1fur                     | Finish               |
|------------------------|---------------------------|---------------------------|---------------------------|--------------------------|--------------------------|--------------------------|----------------------|
| Section Times          | 0:15.79 [11]<br>(0:15.79) | 0:27.48 [11]<br>(0:11.69) | 0:39.24 [10]<br>(0:11.76) | 0:50.96 [8]<br>(0:11.72) | 1:02.77 [5]<br>(0:11.81) | 1:15.95 [4]<br>(0:13.18) | 1:30.32<br>(0:14.37) |
| Average Speed [mi/h]   | 28.6                      | 38.5                      | 38.3                      | 38.5                     | 38.1                     | 34.2                     | 31.0                 |
| Top Speed [mi/h]       | 35.5                      | 39.0                      | 39.0                      | 38.9                     | 39.0                     | 38.4                     | 34.0                 |
| Avg. Dist. to Rail [m] | 26.6                      | 27.7                      | 28.1                      | 29.1                     | 28.5                     | 28.6                     | 29.7                 |
| Avg. Stride Freq. [Hz] | 2.3                       | 2.5                       | 2.5                       | 2.5                      | 2.4                      | 2.3                      | 2.2                  |
| Avg. Stride Length [m] | 5.6                       | 6.9                       | 7.0                       | 7.0                      | 7.0                      | 6.6                      | 6.2                  |

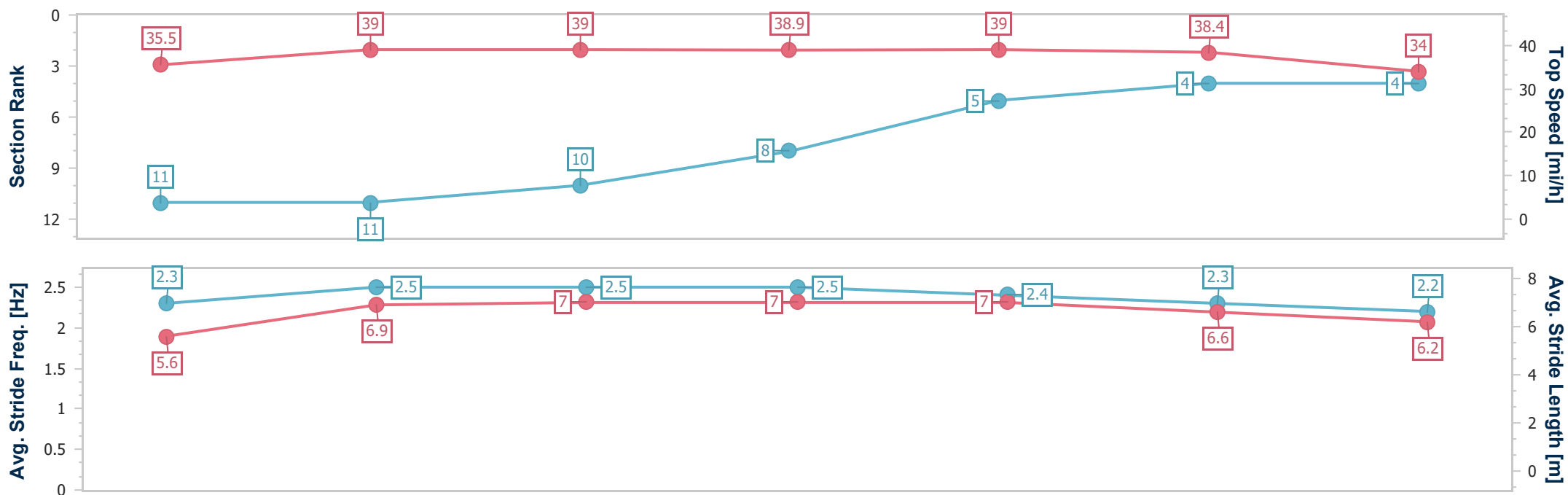

- [ ] Ranking at each section and finish
- .-.- No data available at this section
- NA No data available



|                                |                |
|--------------------------------|----------------|
| Horse Name                     | Final Watch    |
| Final Rank                     | 5              |
| Fastest Section Time (Section) | 0:11.76 (3fur) |
| Top Speed [mi/h] (Section)     | 39.1 (2fur)    |
| Race State                     | Finished       |

Autumn Racing Friday  
 Race 1: Thoroughbred Industry Employee Awards Amateur  
 Jockeys' Handicap - 6F 220Y  
 06 October 2023 - 14:13  
 Track Rating: Good, Weather: Fine, Rail Position: True



| Distance To Go         | 6fur                     | 5fur                     | 4fur                     | 3fur                     | 2fur                     | 1fur                     | Finish               |
|------------------------|--------------------------|--------------------------|--------------------------|--------------------------|--------------------------|--------------------------|----------------------|
| Section Times          | 0:15.54 [8]<br>(0:15.54) | 0:27.35 [7]<br>(0:11.81) | 0:39.12 [6]<br>(0:11.77) | 0:50.88 [5]<br>(0:11.76) | 1:02.81 [6]<br>(0:11.93) | 1:16.25 [6]<br>(0:13.44) | 1:30.51<br>(0:14.26) |
| Average Speed [mi/h]   | 29.2                     | 38.3                     | 38.1                     | 38.3                     | 37.8                     | 33.5                     | 31.2                 |
| Top Speed [mi/h]       | 35.6                     | 38.7                     | 38.8                     | 38.6                     | 39.1                     | 37.9                     | 33.4                 |
| Avg. Dist. to Rail [m] | 22.9                     | 23.6                     | 23.7                     | 23.9                     | 24.3                     | 24.6                     | 24.6                 |
| Avg. Stride Freq. [Hz] | 2.2                      | 2.4                      | 2.4                      | 2.4                      | 2.4                      | 2.3                      | 2.2                  |
| Avg. Stride Length [m] | 6.1                      | 7.2                      | 7.1                      | 7.1                      | 7.0                      | 6.4                      | 6.3                  |

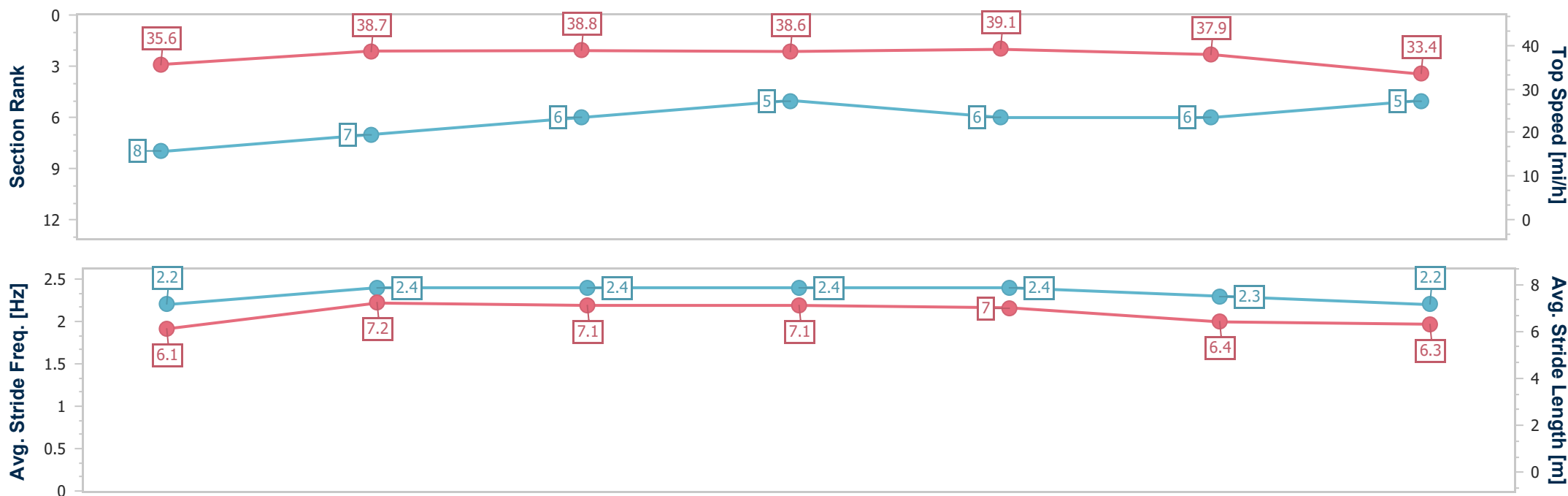

- [ ] Ranking at each section and finish
- .-.- No data available at this section
- NA No data available

|                                |                |
|--------------------------------|----------------|
| Horse Name                     | Flying Secret  |
| Final Rank                     | 6              |
| Fastest Section Time (Section) | 0:11.81 (4fur) |
| Top Speed [mi/h] (Section)     | 38.6 (4fur)    |
| Race State                     | Finished       |

Autumn Racing Friday  
Race 1: Thoroughbred Industry Employee Awards Amateur  
Jockeys' Handicap - 6F 220Y



06 October 2023 - 14:13

Track Rating: Good, Weather: Fine, Rail Position: True

| Distance To Go         | 6fur                     | 5fur                     | 4fur                     | 3fur                     | 2fur                      | 1fur                     | Finish               |  |  |  |  |  |  |
|------------------------|--------------------------|--------------------------|--------------------------|--------------------------|---------------------------|--------------------------|----------------------|--|--|--|--|--|--|
| Section Times          | 0:15.48 [7]<br>(0:15.48) | 0:27.38 [8]<br>(0:11.90) | 0:39.19 [9]<br>(0:11.81) | 0:51.08 [9]<br>(0:11.89) | 1:03.06 [10]<br>(0:11.98) | 1:16.16 [5]<br>(0:13.10) | 1:30.65<br>(0:14.49) |  |  |  |  |  |  |
| Average Speed [mi/h]   | 29.1                     | 37.8                     | 38.1                     | 37.9                     | 37.6                      | 34.5                     | 30.8                 |  |  |  |  |  |  |
| Top Speed [mi/h]       | 35.8                     | 38.3                     | 38.6                     | 38.5                     | 38.6                      | 37.8                     | 34.4                 |  |  |  |  |  |  |
| Avg. Dist. to Rail [m] | 24.5                     | 24.7                     | 24.6                     | 24.9                     | 25.0                      | 24.2                     | 25.1                 |  |  |  |  |  |  |
| Avg. Stride Freq. [Hz] | 2.3                      | 2.5                      | 2.5                      | 2.5                      | 2.5                       | 2.4                      | 2.4                  |  |  |  |  |  |  |
| Avg. Stride Length [m] | 5.8                      | 6.8                      | 6.7                      | 6.8                      | 6.8                       | 6.3                      | 5.9                  |  |  |  |  |  |  |

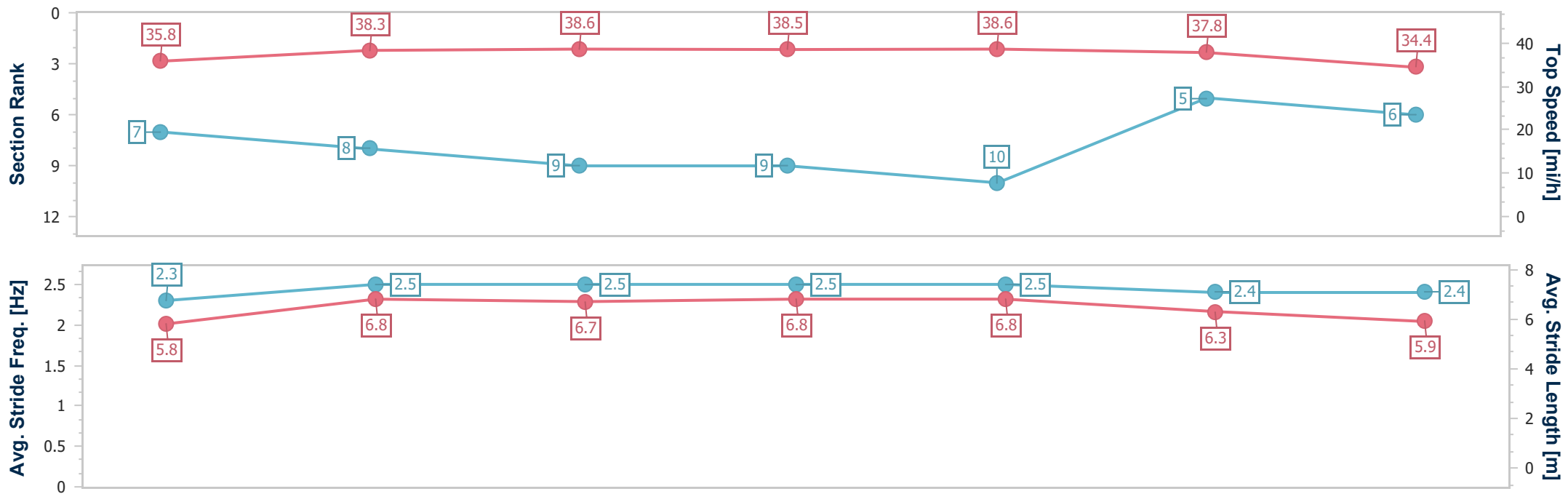

- [ ] Ranking at each section and finish
- .-.- No data available at this section
- NA No data available

|                                |                  |
|--------------------------------|------------------|
| Horse Name                     | Paws For Thought |
| Final Rank                     | 7                |
| Fastest Section Time (Section) | 0:11.84 (4fur)   |
| Top Speed [mi/h] (Section)     | 38.6 (2fur)      |
| Race State                     | Finished         |

Autumn Racing Friday  
 Race 1: Thoroughbred Industry Employee Awards Amateur  
 Jockeys' Handicap - 6F 220Y



06 October 2023 - 14:13

Track Rating: Good, Weather: Fine, Rail Position: True

| Distance To Go         | 6fur                     | 5fur                     | 4fur                     | 3fur                     | 2fur                     | 1fur                     | Finish               |  |  |  |  |  |  |
|------------------------|--------------------------|--------------------------|--------------------------|--------------------------|--------------------------|--------------------------|----------------------|--|--|--|--|--|--|
| Section Times          | 0:15.26 [4]<br>(0:15.26) | 0:27.20 [4]<br>(0:11.94) | 0:39.04 [5]<br>(0:11.84) | 0:50.92 [7]<br>(0:11.88) | 1:02.91 [8]<br>(0:11.99) | 1:16.34 [7]<br>(0:13.43) | 1:31.03<br>(0:14.69) |  |  |  |  |  |  |
| Average Speed [mi/h]   | 29.6                     | 37.6                     | 38.1                     | 38.0                     | 37.6                     | 33.4                     | 30.4                 |  |  |  |  |  |  |
| Top Speed [mi/h]       | 35.6                     | 38.2                     | 38.6                     | 38.4                     | 38.6                     | 37.8                     | 33.4                 |  |  |  |  |  |  |
| Avg. Dist. to Rail [m] | 22.7                     | 23.7                     | 23.9                     | 23.7                     | 23.7                     | 24.3                     | 26.2                 |  |  |  |  |  |  |
| Avg. Stride Freq. [Hz] | 2.4                      | 2.5                      | 2.5                      | 2.5                      | 2.5                      | 2.4                      | 2.3                  |  |  |  |  |  |  |
| Avg. Stride Length [m] | 5.6                      | 6.7                      | 6.7                      | 6.8                      | 6.8                      | 6.2                      | 6.0                  |  |  |  |  |  |  |

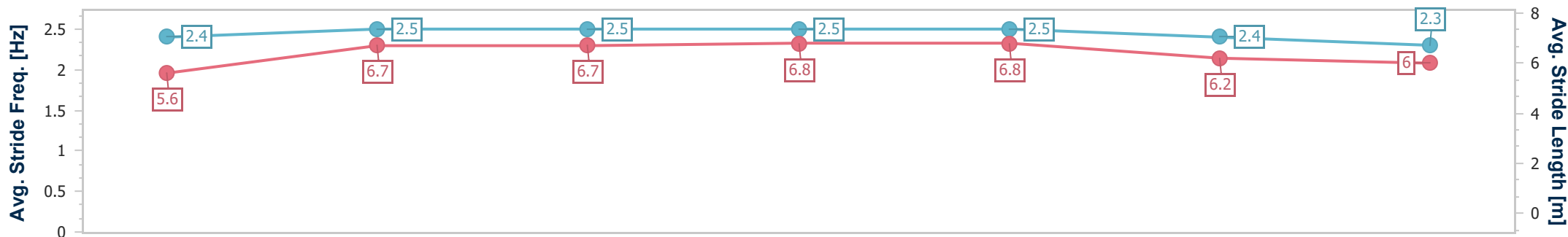
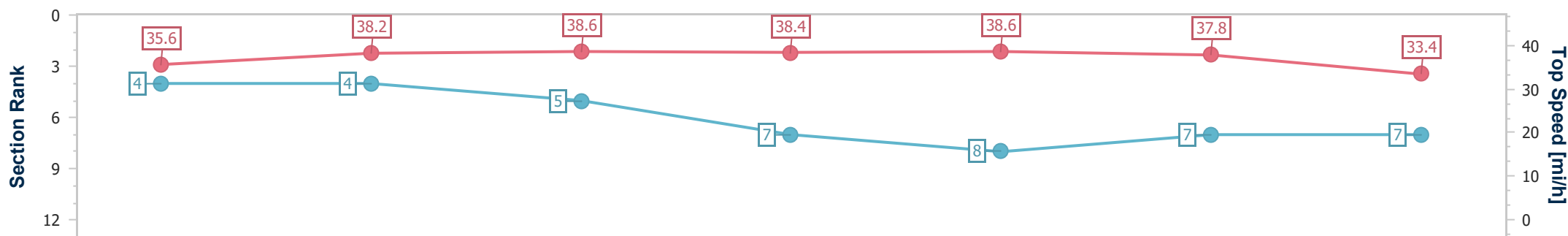

- [ ] Ranking at each section and finish
- .-.- No data available at this section
- NA No data available

|                                |                |
|--------------------------------|----------------|
| Horse Name                     | Kimnkate       |
| Final Rank                     | 8              |
| Fastest Section Time (Section) | 0:11.62 (5fur) |
| Top Speed [mi/h] (Section)     | 39.2 (4fur)    |
| Race State                     | Finished       |

Autumn Racing Friday  
Race 1: Thoroughbred Industry Employee Awards Amateur  
Jockeys' Handicap - 6F 220Y



06 October 2023 - 14:13

Track Rating: Good, Weather: Fine, Rail Position: True

| Distance To Go         | 6fur                      | 5fur                     | 4fur                     | 3fur                     | 2fur                     | 1fur                     | Finish               |  |  |  |  |  |  |
|------------------------|---------------------------|--------------------------|--------------------------|--------------------------|--------------------------|--------------------------|----------------------|--|--|--|--|--|--|
| Section Times          | 0:15.78 [10]<br>(0:15.78) | 0:27.40 [9]<br>(0:11.62) | 0:39.12 [7]<br>(0:11.72) | 0:50.90 [6]<br>(0:11.78) | 1:02.89 [7]<br>(0:11.99) | 1:16.48 [8]<br>(0:13.59) | 1:31.43<br>(0:14.95) |  |  |  |  |  |  |
| Average Speed [mi/h]   | 28.6                      | 38.7                     | 38.5                     | 38.3                     | 37.4                     | 33.2                     | 29.8                 |  |  |  |  |  |  |
| Top Speed [mi/h]       | 35.5                      | 39.2                     | 39.2                     | 38.8                     | 38.9                     | 37.7                     | 33.0                 |  |  |  |  |  |  |
| Avg. Dist. to Rail [m] | 22.3                      | 25.5                     | 25.2                     | 25.5                     | 25.3                     | 26.0                     | 27.7                 |  |  |  |  |  |  |
| Avg. Stride Freq. [Hz] | 2.3                       | 2.6                      | 2.6                      | 2.5                      | 2.5                      | 2.4                      | 2.3                  |  |  |  |  |  |  |
| Avg. Stride Length [m] | 5.6                       | 6.8                      | 6.7                      | 6.7                      | 6.6                      | 6.1                      | 5.9                  |  |  |  |  |  |  |

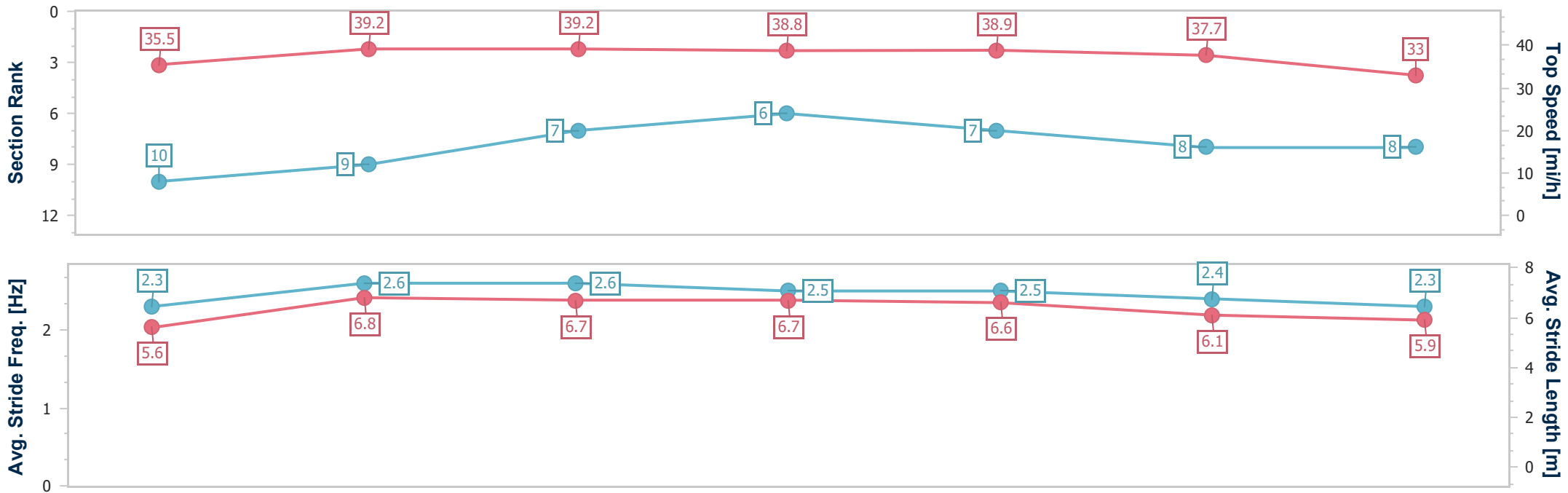

- [ ] Ranking at each section and finish
- .-.- No data available at this section
- NA No data available

|                                |                  |
|--------------------------------|------------------|
| Horse Name                     | Faro De San Juan |
| Final Rank                     | 9                |
| Fastest Section Time (Section) | 0:11.34 (5fur)   |
| Top Speed [mi/h] (Section)     | 40.3 (5fur)      |
| Race State                     | Finished         |

Autumn Racing Friday  
Race 1: Thoroughbred Industry Employee Awards Amateur  
Jockeys' Handicap - 6F 220Y



06 October 2023 - 14:13

Track Rating: Good, Weather: Fine, Rail Position: True

| Distance To Go         | 6fur                      | 5fur                      | 4fur                      | 3fur                      | 2fur                     | 1fur                     | Finish               |
|------------------------|---------------------------|---------------------------|---------------------------|---------------------------|--------------------------|--------------------------|----------------------|
| Section Times          | 0:16.28 [12]<br>(0:16.28) | 0:27.62 [12]<br>(0:11.34) | 0:39.37 [11]<br>(0:11.75) | 0:51.15 [10]<br>(0:11.78) | 1:02.99 [9]<br>(0:11.84) | 1:16.55 [9]<br>(0:13.56) | 1:31.36<br>(0:14.81) |
| Average Speed [mi/h]   | 27.8                      | 39.8                      | 38.3                      | 38.3                      | 38.0                     | 33.3                     | 30.1                 |
| Top Speed [mi/h]       | 37.0                      | 40.3                      | 40.1                      | 38.7                      | 39.3                     | 38.4                     | 32.9                 |
| Avg. Dist. to Rail [m] | 24.7                      | 24.0                      | 23.9                      | 23.6                      | 22.4                     | 19.9                     | 21.4                 |
| Avg. Stride Freq. [Hz] | 2.3                       | 2.6                       | 2.5                       | 2.5                       | 2.5                      | 2.4                      | 2.3                  |
| Avg. Stride Length [m] | 5.5                       | 6.9                       | 6.9                       | 7.0                       | 6.8                      | 6.2                      | 5.9                  |

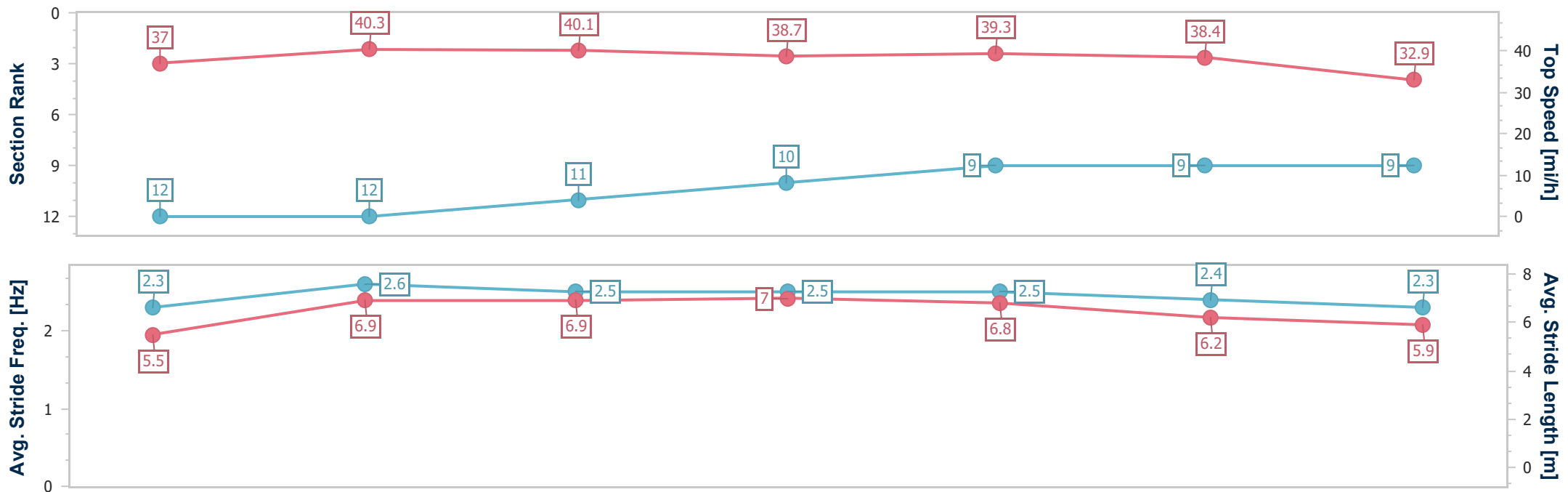

- [ ] Ranking at each section and finish
- .-.-.- No data available at this section
- NA No data available

|                                |                |
|--------------------------------|----------------|
| Horse Name                     | Wyvern         |
| Final Rank                     | 10             |
| Fastest Section Time (Section) | 0:11.88 (5fur) |
| Top Speed [mi/h] (Section)     | 38.4 (2fur)    |
| Race State                     | Finished       |

Autumn Racing Friday  
Race 1: Thoroughbred Industry Employee Awards Amateur  
Jockeys' Handicap - 6F 220Y



06 October 2023 - 14:13

Track Rating: Good, Weather: Fine, Rail Position: True

| Distance To Go         | 6fur                     | 5fur                      | 4fur                      | 3fur                      | 2fur                      | 1fur                      | Finish               |
|------------------------|--------------------------|---------------------------|---------------------------|---------------------------|---------------------------|---------------------------|----------------------|
| Section Times          | 0:15.57 [9]<br>(0:15.57) | 0:27.45 [10]<br>(0:11.88) | 0:39.45 [12]<br>(0:12.00) | 0:51.43 [12]<br>(0:11.98) | 1:03.52 [11]<br>(0:12.09) | 1:17.07 [10]<br>(0:13.55) | 1:31.80<br>(0:14.73) |
| Average Speed [mi/h]   | 29.1                     | 38.0                      | 37.5                      | 37.5                      | 37.2                      | 33.1                      | 30.5                 |
| Top Speed [mi/h]       | 35.6                     | 38.4                      | 38.3                      | 38.1                      | 38.4                      | 37.5                      | 33.1                 |
| Avg. Dist. to Rail [m] | 21.2                     | 22.4                      | 22.6                      | 22.7                      | 23.8                      | 26.2                      | 28.7                 |
| Avg. Stride Freq. [Hz] | 2.2                      | 2.4                       | 2.4                       | 2.4                       | 2.4                       | 2.3                       | 2.2                  |
| Avg. Stride Length [m] | 5.9                      | 6.9                       | 7.0                       | 7.0                       | 7.1                       | 6.5                       | 6.2                  |

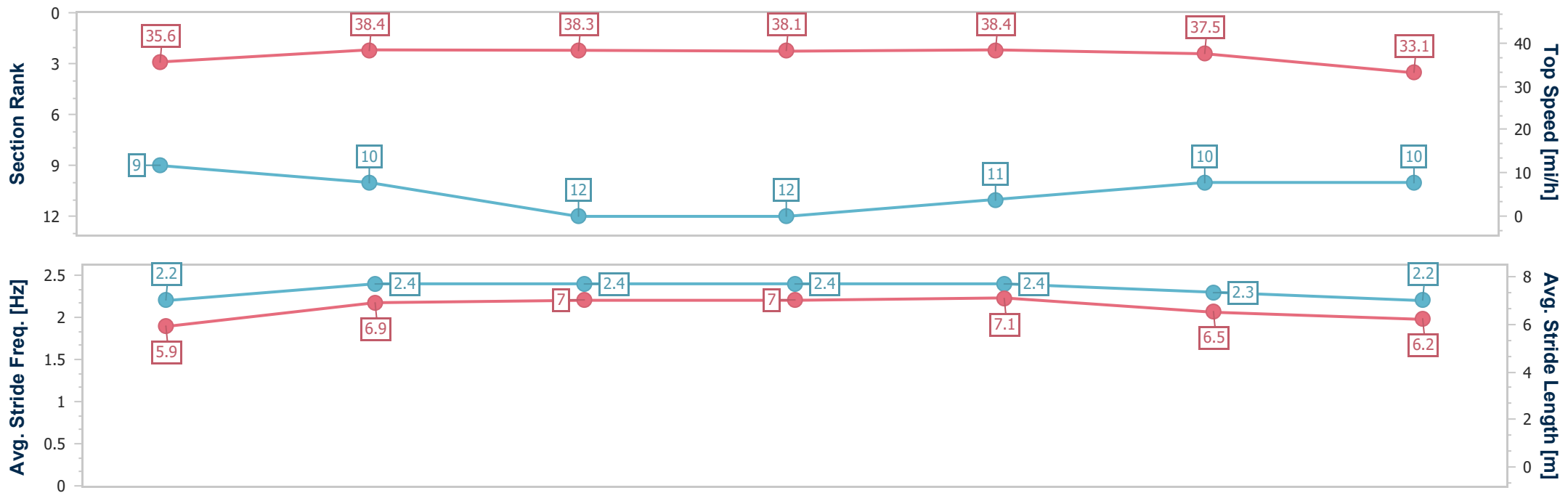

- [ ] Ranking at each section and finish
- .-.- No data available at this section
- NA No data available



|                                |                |
|--------------------------------|----------------|
| Horse Name                     | Crystal Casque |
| Final Rank                     | 11             |
| Fastest Section Time (Section) | 0:11.91 (5fur) |
| Top Speed [mi/h] (Section)     | 38.4 (4fur)    |
| Race State                     | Finished       |

Autumn Racing Friday  
Race 1: Thoroughbred Industry Employee Awards Amateur  
Jockeys' Handicap - 6F 220Y



06 October 2023 - 14:13

Track Rating: Good, Weather: Fine, Rail Position: True

| Distance To Go         | 6fur                     | 5fur                     | 4fur                     | 3fur                      | 2fur                      | 1fur                      | Finish               |
|------------------------|--------------------------|--------------------------|--------------------------|---------------------------|---------------------------|---------------------------|----------------------|
| Section Times          | 0:15.33 [5]<br>(0:15.33) | 0:27.24 [6]<br>(0:11.91) | 0:39.18 [8]<br>(0:11.94) | 0:51.21 [11]<br>(0:12.03) | 1:03.66 [12]<br>(0:12.45) | 1:17.43 [12]<br>(0:13.77) | 1:32.03<br>(0:14.60) |
| Average Speed [mi/h]   | 29.5                     | 37.7                     | 37.8                     | 37.4                      | 36.2                      | 32.7                      | 30.6                 |
| Top Speed [mi/h]       | 36.3                     | 38.3                     | 38.4                     | 38.1                      | 37.8                      | 36.3                      | 32.6                 |
| Avg. Dist. to Rail [m] | 27.9                     | 27.8                     | 27.3                     | 27.4                      | 26.8                      | 26.5                      | 27.7                 |
| Avg. Stride Freq. [Hz] | 2.2                      | 2.4                      | 2.4                      | 2.3                       | 2.3                       | 2.3                       | 2.2                  |
| Avg. Stride Length [m] | 5.9                      | 7.0                      | 7.1                      | 7.2                       | 7.1                       | 6.4                       | 6.2                  |

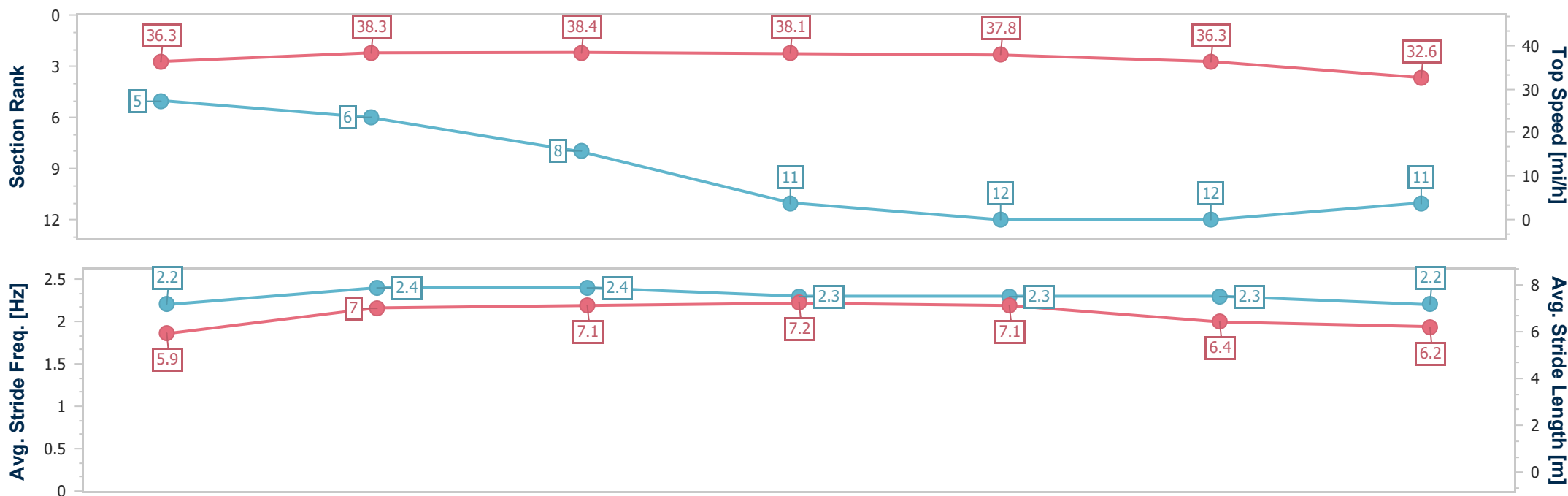

- [ ] Ranking at each section and finish
- .-.- No data available at this section
- NA No data available

|                                |                |
|--------------------------------|----------------|
| Horse Name                     | Amber Island   |
| Final Rank                     | 12             |
| Fastest Section Time (Section) | 0:11.68 (4fur) |
| Top Speed [mi/h] (Section)     | 39.1 (4fur)    |
| Race State                     | Finished       |

Autumn Racing Friday  
Race 1: Thoroughbred Industry Employee Awards Amateur  
Jockeys' Handicap - 6F 220Y



06 October 2023 - 14:13

Track Rating: Good, Weather: Fine, Rail Position: True

| Distance To Go         | 6fur                     | 5fur                     | 4fur                     | 3fur                     | 2fur                     | 1fur                      | Finish               |  |  |  |  |  |  |
|------------------------|--------------------------|--------------------------|--------------------------|--------------------------|--------------------------|---------------------------|----------------------|--|--|--|--|--|--|
| Section Times          | 0:15.12 [1]<br>(0:15.12) | 0:26.86 [2]<br>(0:11.74) | 0:38.54 [2]<br>(0:11.68) | 0:50.48 [3]<br>(0:11.94) | 1:02.74 [4]<br>(0:12.26) | 1:17.08 [11]<br>(0:14.34) | 1:34.47<br>(0:17.39) |  |  |  |  |  |  |
| Average Speed [mi/h]   | 29.9                     | 38.4                     | 38.4                     | 37.8                     | 36.7                     | 31.3                      | 25.7                 |  |  |  |  |  |  |
| Top Speed [mi/h]       | 36.6                     | 38.8                     | 39.1                     | 38.9                     | 38.3                     | 36.8                      | 30.9                 |  |  |  |  |  |  |
| Avg. Dist. to Rail [m] | 20.3                     | 22.7                     | 23.3                     | 23.0                     | 22.4                     | 21.2                      | 21.4                 |  |  |  |  |  |  |
| Avg. Stride Freq. [Hz] | 2.3                      | 2.5                      | 2.5                      | 2.5                      | 2.5                      | 2.4                       | 2.1                  |  |  |  |  |  |  |
| Avg. Stride Length [m] | 5.9                      | 6.9                      | 6.8                      | 6.8                      | 6.6                      | 6.0                       | 5.4                  |  |  |  |  |  |  |

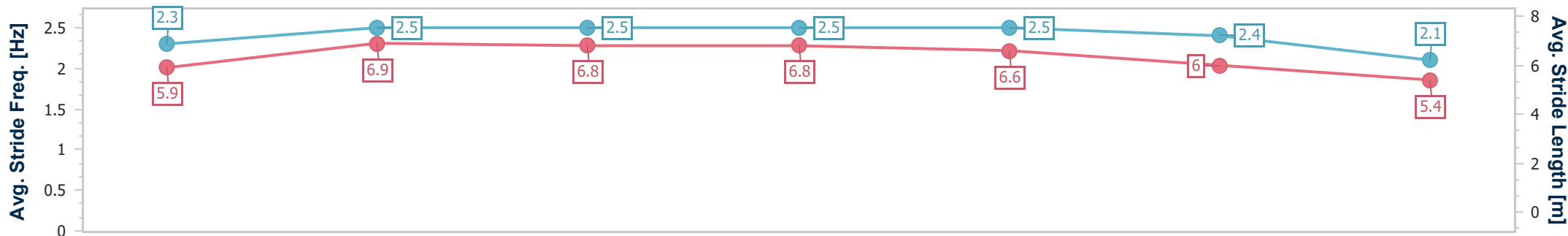
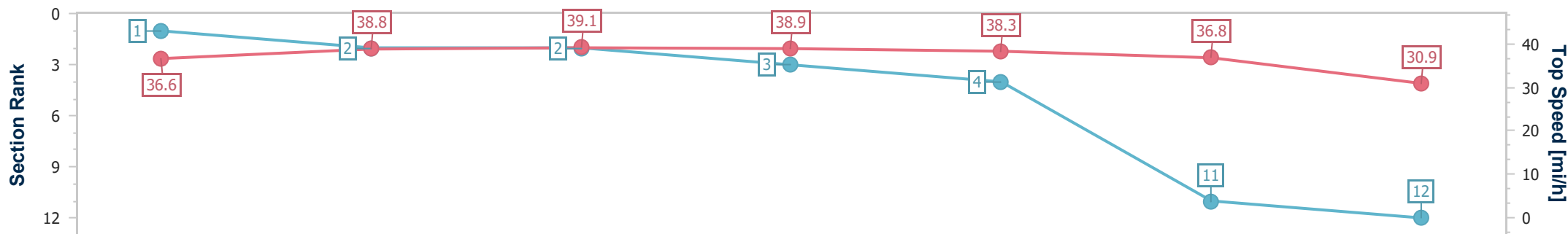

- [ ] Ranking at each section and finish
- .-.- No data available at this section
- NA No data available