

Royal Ascot Trials Day

Race 1: Howden Manny Mercer Apprentice Handicap (Str) - 1M

03 May 2023 - 13:31



Track Rating: Good, Weather: Fine, Rail Position: True

Distance To Go				7fur	6fur	5fur	4fur	3fur	2fur	1fur	Last 3fur			
Field Times				0:15.72 (0:15.72)	0:27.84 (0:12.12)	0:40.05 (0:12.21)	0:52.41 (0:12.36)	1:04.70 (0:12.29)	1:17.03 (0:12.33)	1:30.01 (0:12.98)	0:38.54			
Rank	Nr.	Horse	Barrier	Top Speed [mi/h]	Fastest Section								Distance Travelled [m]	
1	3	CHASING APHRODITE	12	37.6	0:12.13	0:16.14 [8]	0:28.38 [6]	0:40.59 [6]	0:52.92 [6]	1:05.29 [8]	1:17.42 [8]	1:30.16 [4]	0:37.95	1609
		Pierre-Louis Jamin		2fur	2fur	(0:16.14)	(0:12.24)	(0:12.21)	(0:12.33)	(0:12.37)	(0:12.13)	(0:12.74)		
2	4	YAANAAS	3	38.0	0:12.19	0:16.12 [7]	0:28.41 [7]	0:40.61 [7]	0:52.97 [8]	1:05.16 [6]	1:17.36 [6]	1:30.12 [3]	0:38.37	1609
		Aidan Keeley		2fur	3fur	(0:16.12)	(0:12.29)	(0:12.20)	(0:12.36)	(0:12.19)	(0:12.20)	(0:12.76)		
3	2	HELM ROCK	8	38.0	0:12.15	0:15.76 [2]	0:28.02 [3]	0:40.24 [4]	0:52.59 [4]	1:04.89 [4]	1:17.04 [2]	1:30.07 [2]	0:38.60	1608
		William Carver		2fur	2fur	(0:15.76)	(0:12.26)	(0:12.22)	(0:12.35)	(0:12.30)	(0:12.15)	(0:13.03)		
4	5	BALTIMORE BOY	11	38.4	0:12.04	0:16.46 [14]	0:28.81 [15]	0:40.99 [14]	0:53.26 [12]	1:05.32 [9]	1:17.36 [7]	1:30.24 [5]	0:38.22	1609
		Joe Bradnam		2fur	2fur	(0:16.46)	(0:12.35)	(0:12.18)	(0:12.27)	(0:12.06)	(0:12.04)	(0:12.88)		
5	12	GLOBAL ESTEEM	15	38.0	0:12.11	0:15.89 [5]	0:28.12 [5]	0:40.32 [5]	0:52.71 [5]	1:04.95 [5]	1:17.06 [3]	1:30.01 [1]	0:38.70	1607
		Kaiya Fraser		2fur	2fur	(0:15.89)	(0:12.23)	(0:12.20)	(0:12.39)	(0:12.24)	(0:12.11)	(0:12.95)		
6	10	KEYSER SOZE	1	38.2	0:12.09	0:16.61 [15]	0:28.78 [14]	0:40.87 [11]	0:53.23 [11]	1:05.43 [11]	1:17.54 [10]	1:30.62 [8]	0:38.42	1607
		Harry Russell		2fur	5fur	(0:16.61)	(0:12.17)	(0:12.09)	(0:12.36)	(0:12.20)	(0:12.11)	(0:13.08)		
7	11	REPertoire	5	37.6	0:12.20	0:16.44 [13]	0:28.76 [13]	0:41.07 [15]	0:53.65 [15]	1:06.02 [15]	1:18.22 [14]	1:30.91 [10]	0:38.13	1607
		Olivia Haines		2fur	2fur	(0:16.44)	(0:12.32)	(0:12.31)	(0:12.58)	(0:12.37)	(0:12.20)	(0:12.69)		
8	9	FANTASY BELIEVER	9	37.9	0:12.19	0:16.16 [9]	0:28.45 [9]	0:40.64 [8]	0:52.95 [7]	1:05.23 [7]	1:17.43 [9]	1:30.68 [9]	0:38.95	1608
		Callum Hutchinson		2fur	5fur	(0:16.16)	(0:12.29)	(0:12.19)	(0:12.31)	(0:12.28)	(0:12.20)	(0:13.25)		
9	6	RAISING SAND	4	37.9	0:12.14	0:15.85 [4]	0:28.07 [4]	0:40.21 [3]	0:52.57 [3]	1:04.79 [3]	1:17.10 [4]	1:30.39 [6]	0:39.61	1606
		Saffie Osborne		2fur	5fur	(0:15.85)	(0:12.22)	(0:12.14)	(0:12.36)	(0:12.22)	(0:12.31)	(0:13.29)		
10	13	DEVASBOY	13	37.9	0:12.17	0:16.32 [10]	0:28.64 [11]	0:40.98 [13]	0:53.46 [14]	1:05.76 [13]	1:17.93 [13]	1:30.93 [11]	0:38.83	1609
		Ben Sanderson		2fur	2fur	(0:16.32)	(0:12.32)	(0:12.34)	(0:12.48)	(0:12.30)	(0:12.17)	(0:13.00)		

Royal Ascot Trials Day

Race 1: Howden Manny Mercer Apprentice Handicap (Str) - 1M

03 May 2023 - 13:31



Track Rating: Good, Weather: Fine, Rail Position: True

Distance To Go				7fur	6fur	5fur	4fur	3fur	2fur	1fur	Last 3fur			
Field Times				0:15.72 (0:15.72)	0:27.84 (0:12.12)	0:40.05 (0:12.21)	0:52.41 (0:12.36)	1:04.70 (0:12.29)	1:17.03 (0:12.33)	1:30.01 (0:12.98)	0:38.54			
Rank	Nr.	Horse	Barrier	Top Speed [mi/h]	Fastest Section								Distance Travelled [m]	
11	14	TWO TEMPTING	7	37.7	0:12.12	0:15.72 [1]	0:27.84 [1]	0:40.05 [1]	0:52.41 [1]	1:04.70 [1]	1:17.03 [1]	1:30.50 [7]	0:40.27	1608
		A J Farragher		5fur	6fur	(0:15.72)	(0:12.12)	(0:12.21)	(0:12.36)	(0:12.29)	(0:12.33)	(0:13.47)		
12	1	BEAR FORCE ONE	14	37.6	0:12.11	0:15.76 [3]	0:27.87 [2]	0:40.08 [2]	0:52.44 [2]	1:04.74 [2]	1:17.25 [5]	1:31.08 [12]	0:41.20	1603
		Billy Loughnane		5fur	6fur	(0:15.76)	(0:12.11)	(0:12.21)	(0:12.36)	(0:12.30)	(0:12.51)	(0:13.83)		
13	15	DIFFIDENT SPIRIT	10	37.7	0:12.23	0:16.38 [11]	0:28.65 [12]	0:40.88 [12]	0:53.22 [10]	1:05.48 [12]	1:17.85 [12]	1:31.66 [14]	0:40.49	1609
		Tommie Jakes		2fur	5fur	(0:16.38)	(0:12.27)	(0:12.23)	(0:12.34)	(0:12.26)	(0:12.37)	(0:13.81)		
14	8	SAGANO	6	37.2	0:12.33	0:16.05 [6]	0:28.44 [8]	0:40.77 [10]	0:53.32 [13]	1:05.95 [14]	1:18.45 [15]	1:31.93 [15]	0:40.29	1607
		Anna Gibson		5fur	5fur	(0:16.05)	(0:12.39)	(0:12.33)	(0:12.55)	(0:12.63)	(0:12.50)	(0:13.48)		
15	7	AL MARMAR	2	37.9	0:12.14	0:16.38 [11]	0:28.59 [10]	0:40.73 [9]	0:53.10 [9]	1:05.34 [10]	1:17.78 [11]	1:31.60 [13]	0:41.00	1611
		Harry Davies		2fur	5fur	(0:16.38)	(0:12.21)	(0:12.14)	(0:12.37)	(0:12.24)	(0:12.44)	(0:13.82)		

Royal Ascot Trials Day

Race 1: Howden Manny Mercer Apprentice Handicap (Str) - 1M

03 May 2023 - 13:31



Track Rating: Good, Weather: Fine, Rail Position: True

Distance To Go				Finish				Last 3fur		
Field Times				1:43.24				0:38.54		
				(0:13.23)						
Rank	Nr.	Horse	Barrier	Top Speed [mi/h]	Fastest Section	Official Finish Time			Distance Travelled [m]	
1	3	CHASING APHRODITE	12	37.6	0:12.13	1:43.24	1:43.01		0:37.95	1609
		Pierre-Louis Jamin		2fur	2fur	(0:13.08)				
2	4	YAANAAS	3	38.0	0:12.19	1:43.53	1:43.24		0:38.37	1609
		Aidan Keeley		2fur	3fur	(0:13.41)				
3	2	HELM ROCK	8	38.0	0:12.15	1:43.49	1:43.31		0:38.60	1608
		William Carver		2fur	2fur	(0:13.42)				
4	5	BALTIMORE BOY	11	38.4	0:12.04	1:43.54	1:43.38		0:38.22	1609
		Joe Bradnam		2fur	2fur	(0:13.30)				
5	12	GLOBAL ESTEEM	15	38.0	0:12.11	1:43.65	1:43.48		0:38.70	1607
		Kaiya Fraser		2fur	2fur	(0:13.64)				
6	10	KEYSER SOZE	1	38.2	0:12.09	1:43.85	1:43.66		0:38.42	1607
		Harry Russell		2fur	5fur	(0:13.23)				
7	11	REPertoire	5	37.6	0:12.20	1:44.15	1:43.82		0:38.13	1607
		Olivia Haines		2fur	2fur	(0:13.24)				
8	9	FANTASY BELIEVER	9	37.9	0:12.19	1:44.18	1:43.89		0:38.95	1608
		Callum Hutchinson		2fur	5fur	(0:13.50)				
9	6	RAISING SAND	4	37.9	0:12.14	1:44.40	1:44.22		0:39.61	1606
		Saffie Osborne		2fur	5fur	(0:14.01)				
10	13	DEVASBOY	13	37.9	0:12.17	1:44.59	1:44.24		0:38.83	1609
		Ben Sanderson		2fur	2fur	(0:13.66)				

Royal Ascot Trials Day

Race 1: Howden Manny Mercer Apprentice Handicap (Str) - 1M

03 May 2023 - 13:31



Track Rating: Good, Weather: Fine, Rail Position: True

Distance To Go				Finish				Last 3fur		
Field Times				1:43.24		(0:13.23)		0:38.54		
Rank	Nr.	Horse	Barrier	Top Speed [mi/h]	Fastest Section	Official Finish Time			Distance Travelled [m]	
11	14	TWO TEMPTING	7	37.7	0:12.12	1:44.97	1:44.75		0:40.27	1608
		A J Farragher		5fur	6fur	(0:14.47)				
12	1	BEAR FORCE ONE	14	37.6	0:12.11	1:45.94	1:45.71		0:41.20	1603
		Billy Loughnane		5fur	6fur	(0:14.86)				
13	15	DIFFIDENT SPIRIT	10	37.7	0:12.23	1:45.97	1:45.77		0:40.49	1609
		Tommie Jakes		2fur	5fur	(0:14.31)				
14	8	SAGANO	6	37.2	0:12.33	1:46.24	1:46.01		0:40.29	1607
		Anna Gibson		5fur	5fur	(0:14.31)				
15	7	AL MARMAR	2	37.9	0:12.14	1:46.34	1:46.20		0:41.00	1611
		Harry Davies		2fur	5fur	(0:14.74)				

Horse Name	Chasing Aphrodite
Final Rank	1
Fastest Section Time (Section)	0:12.13 (2fur)
Top Speed [mi/h] (Section)	37.6 (2fur)
Race State	Finished

Royal Ascot Trials Day

Race 1: Howden Manny Mercer Apprentice Handicap (Str) - 1M 

03 May 2023 - 13:31

Track Rating: Good, Weather: Fine, Rail Position: True

Distance To Go	7fur	6fur	5fur	4fur	3fur	2fur	1fur	Finish					
Section Times	0:16.14 [8] (0:16.14)	0:28.38 [6] (0:12.24)	0:40.59 [6] (0:12.21)	0:52.92 [6] (0:12.33)	1:05.29 [8] (0:12.37)	1:17.42 [8] (0:12.13)	1:30.16 [4] (0:12.74)	1:43.24 (0:13.08)					
Average Speed [mi/h]	28.0	36.7	36.9	36.6	36.4	37.2	35.2	34.1					
Top Speed [mi/h]	34.1	37.2	37.6	37.3	36.9	37.6	37.5	35.5					
Avg. Dist. to Rail [m]	21.2	20.6	21.1	21.7	21.8	22.2	22.4	20.8					
Avg. Stride Freq. [Hz]	2.2	2.3	2.3	2.3	2.2	2.3	2.3	2.2					
Avg. Stride Length [m]	5.7	7.2	7.3	7.2	7.3	7.2	6.9	6.9					

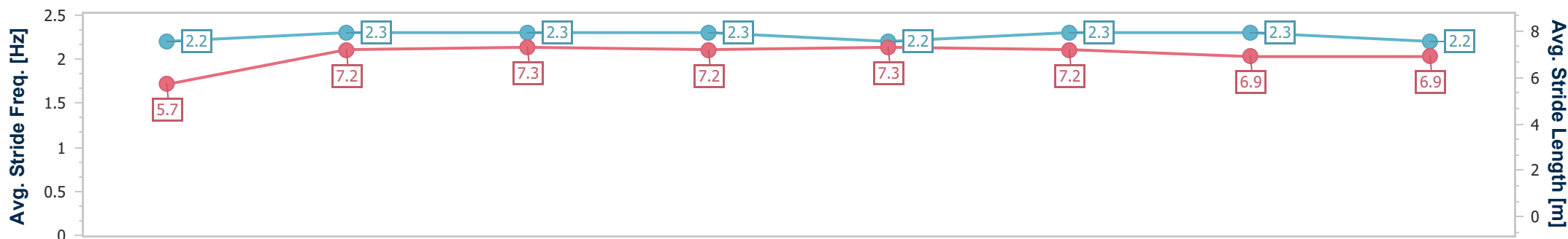
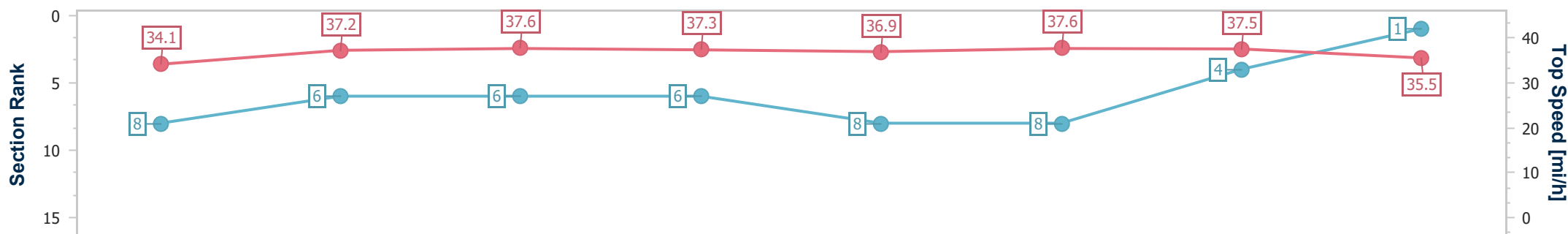

- [] Ranking at each section and finish
- .-.-.- No data available at this section
- NA No data available



Horse Name	Yaanaas
Final Rank	2
Fastest Section Time (Section)	0:12.19 (3fur)
Top Speed [mi/h] (Section)	38.0 (2fur)
Race State	Finished

Royal Ascot Trials Day
Race 1: Howden Manny Mercer Apprentice Handicap (Str) - 1M 
03 May 2023 - 13:31
Track Rating: Good, Weather: Fine, Rail Position: True

Distance To Go	7fur	6fur	5fur	4fur	3fur	2fur	1fur	Finish					
Section Times	0:16.12 [7] (0:16.12)	0:28.41 [7] (0:12.29)	0:40.61 [7] (0:12.20)	0:52.97 [8] (0:12.36)	1:05.16 [6] (0:12.19)	1:17.36 [6] (0:12.20)	1:30.12 [3] (0:12.76)	1:43.53 (0:13.41)					
Average Speed [mi/h]	28.1	36.5	36.9	36.4	36.9	37.0	35.4	33.2					
Top Speed [mi/h]	34.8	37.2	37.4	37.4	37.5	38.0	37.2	35.5					
Avg. Dist. to Rail [m]	12.7	16.7	17.4	18.3	17.8	16.9	13.9	13.7					
Avg. Stride Freq. [Hz]	2.3	2.4	2.4	2.3	2.3	2.3	2.3	2.2					
Avg. Stride Length [m]	5.5	6.9	7.0	7.0	7.0	7.1	6.8	6.6					

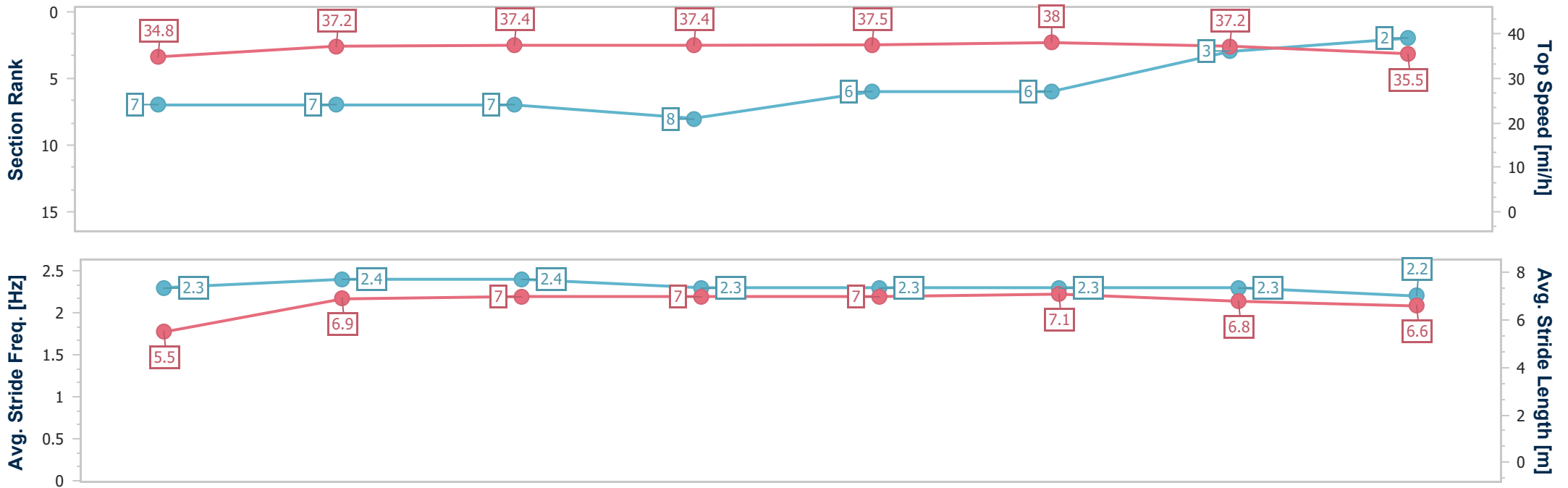

- [] Ranking at each section and finish
- .-.- No data available at this section
- NA No data available

Horse Name	Helm Rock
Final Rank	3
Fastest Section Time (Section)	0:12.15 (2fur)
Top Speed [mi/h] (Section)	38.0 (2fur)
Race State	Finished

Royal Ascot Trials Day
 Race 1: Howden Manny Mercer Apprentice Handicap (Str) - 1M 
 03 May 2023 - 13:31
 Track Rating: Good, Weather: Fine, Rail Position: True

Distance To Go	7fur	6fur	5fur	4fur	3fur	2fur	1fur	Finish					
Section Times	0:15.76 [2] (0:15.76)	0:28.02 [3] (0:12.26)	0:40.24 [4] (0:12.22)	0:52.59 [4] (0:12.35)	1:04.89 [4] (0:12.30)	1:17.04 [2] (0:12.15)	1:30.07 [2] (0:13.03)	1:43.49 (0:13.42)					
Average Speed [mi/h]	28.4	36.9	36.8	36.4	36.5	37.2	34.6	33.2					
Top Speed [mi/h]	34.2	37.2	37.4	37.2	37.2	38.0	37.3	34.7					
Avg. Dist. to Rail [m]	17.6	18.8	19.4	20.1	19.8	19.1	17.0	15.7					
Avg. Stride Freq. [Hz]	2.2	2.3	2.3	2.3	2.3	2.3	2.3	2.3					
Avg. Stride Length [m]	5.8	7.2	7.2	7.2	7.2	7.2	6.7	6.5					

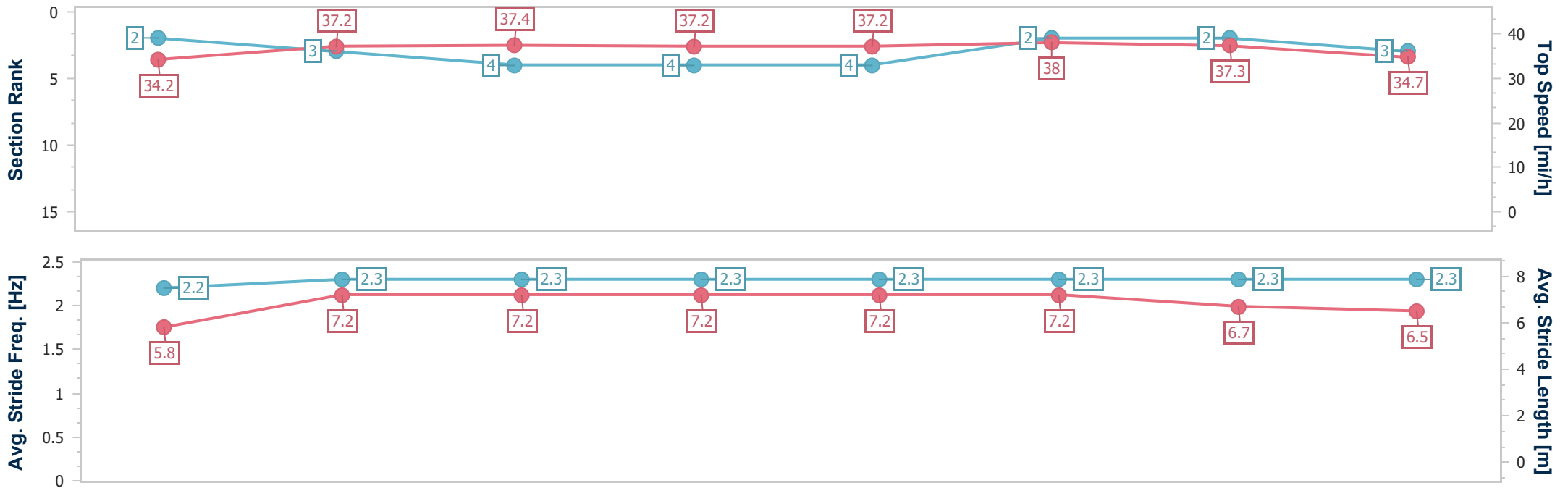

- [] Ranking at each section and finish
- .-.- No data available at this section
- NA No data available

Horse Name	Baltimore Boy
Final Rank	4
Fastest Section Time (Section)	0:12.04 (2fur)
Top Speed [mi/h] (Section)	38.4 (2fur)
Race State	Finished

Royal Ascot Trials Day

Race 1: Howden Manny Mercer Apprentice Handicap (Str) - 1M 

03 May 2023 - 13:31

Track Rating: Good, Weather: Fine, Rail Position: True

Distance To Go	7fur	6fur	5fur	4fur	3fur	2fur	1fur	Finish					
Section Times	0:16.46 [14] (0:16.46)	0:28.81 [15] (0:12.35)	0:40.99 [14] (0:12.18)	0:53.26 [12] (0:12.27)	1:05.32 [9] (0:12.06)	1:17.36 [7] (0:12.04)	1:30.24 [5] (0:12.88)	1:43.54 (0:13.30)					
Average Speed [mi/h]	27.4	36.5	37.0	36.6	37.5	37.3	35.0	33.5					
Top Speed [mi/h]	34.0	37.0	37.7	37.3	37.8	38.4	37.6	35.2					
Avg. Dist. to Rail [m]	20.4	19.6	20.9	21.8	21.7	21.9	21.9	19.6					
Avg. Stride Freq. [Hz]	2.0	2.2	2.2	2.2	2.3	2.3	2.3	2.2					
Avg. Stride Length [m]	6.0	7.4	7.4	7.3	7.4	7.2	6.9	6.9					

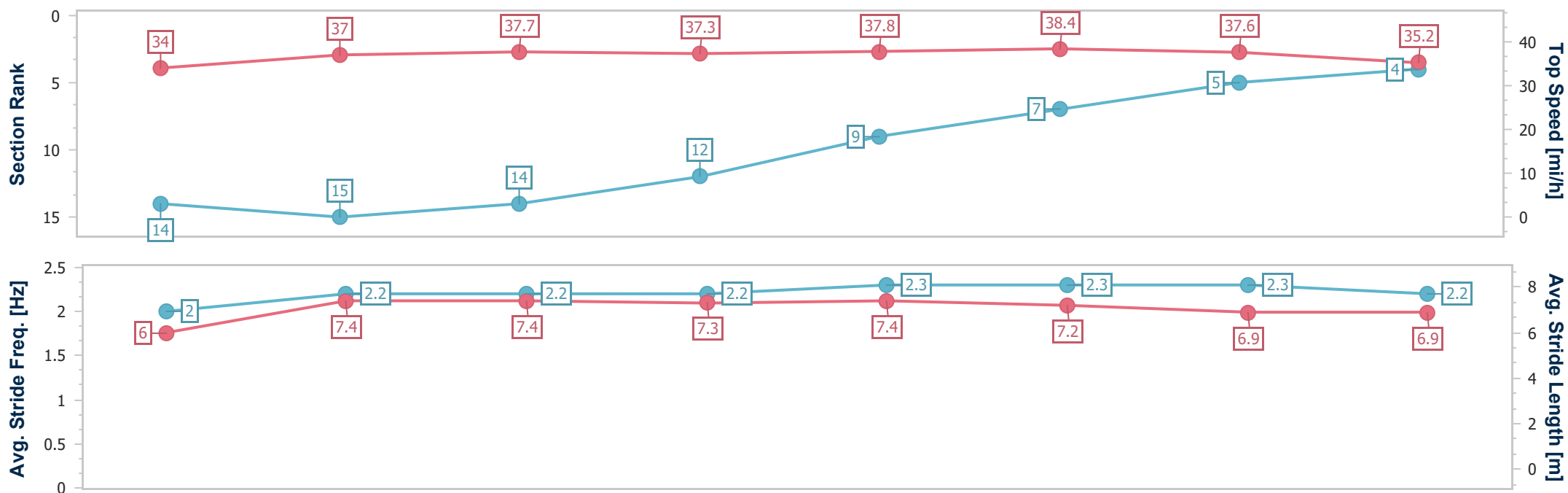

- [] Ranking at each section and finish
- .-.- No data available at this section
- NA No data available



Horse Name	Global Esteem
Final Rank	5
Fastest Section Time (Section)	0:12.11 (2fur)
Top Speed [mi/h] (Section)	38.0 (2fur)
Race State	Finished

Royal Ascot Trials Day

Race 1: Howden Manny Mercer Apprentice Handicap (Str) - 1M 

03 May 2023 - 13:31

Track Rating: Good, Weather: Fine, Rail Position: True

Distance To Go	7fur	6fur	5fur	4fur	3fur	2fur	1fur	Finish					
Section Times	0:15.89 [5] (0:15.89)	0:28.12 [5] (0:12.23)	0:40.32 [5] (0:12.20)	0:52.71 [5] (0:12.39)	1:04.95 [5] (0:12.24)	1:17.06 [3] (0:12.11)	1:30.01 [1] (0:12.95)	1:43.65 (0:13.64)					
Average Speed [mi/h]	28.5	36.9	36.9	36.2	36.8	37.1	34.4	32.8					
Top Speed [mi/h]	34.3	37.3	37.6	37.2	37.3	38.0	37.5	35.0					
Avg. Dist. to Rail [m]	21.9	19.4	19.9	20.3	20.4	20.7	18.7	17.3					
Avg. Stride Freq. [Hz]	2.1	2.2	2.2	2.2	2.2	2.2	2.2	2.1					
Avg. Stride Length [m]	6.0	7.4	7.5	7.5	7.6	7.5	7.0	6.8					

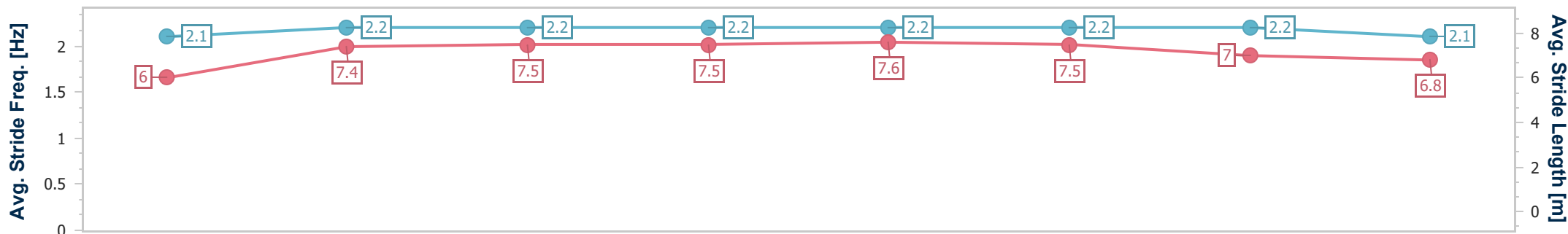
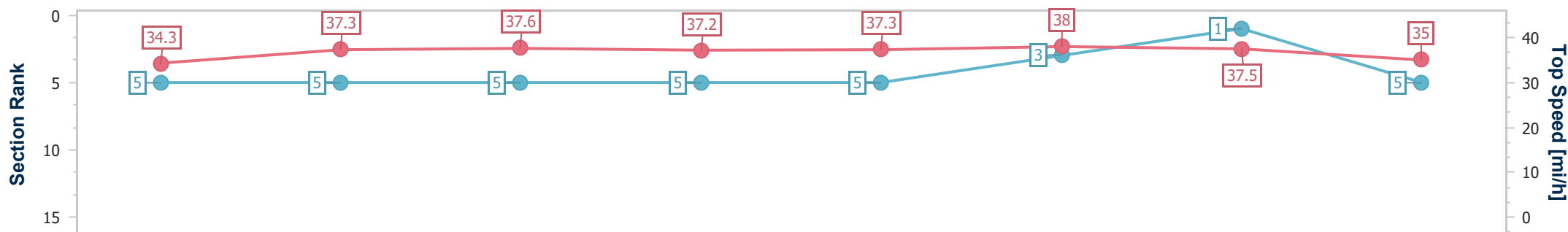

- [] Ranking at each section and finish
- .-.- No data available at this section
- NA No data available



Horse Name	Keyser Soze
Final Rank	6
Fastest Section Time (Section)	0:12.09 (5fur)
Top Speed [mi/h] (Section)	38.2 (2fur)
Race State	Finished

Royal Ascot Trials Day
 Race 1: Howden Manny Mercer Apprentice Handicap (Str) - 1M 
 03 May 2023 - 13:31
 Track Rating: Good, Weather: Fine, Rail Position: True

Distance To Go	7fur	6fur	5fur	4fur	3fur	2fur	1fur	Finish					
Section Times	0:16.61 [15] (0:16.61)	0:28.78 [14] (0:12.17)	0:40.87 [11] (0:12.09)	0:53.23 [11] (0:12.36)	1:05.43 [11] (0:12.20)	1:17.54 [10] (0:12.11)	1:30.62 [8] (0:13.08)	1:43.85 (0:13.23)					
Average Speed [mi/h]	27.2	36.8	37.3	36.4	36.9	37.2	34.3	33.7					
Top Speed [mi/h]	34.5	37.5	37.8	37.6	37.3	38.2	37.4	34.4					
Avg. Dist. to Rail [m]	11.5	16.5	17.3	17.9	17.1	16.3	13.3	11.8					
Avg. Stride Freq. [Hz]	2.0	2.2	2.2	2.2	2.2	2.3	2.2	2.2					
Avg. Stride Length [m]	5.9	7.4	7.4	7.4	7.4	7.3	6.9	6.8					

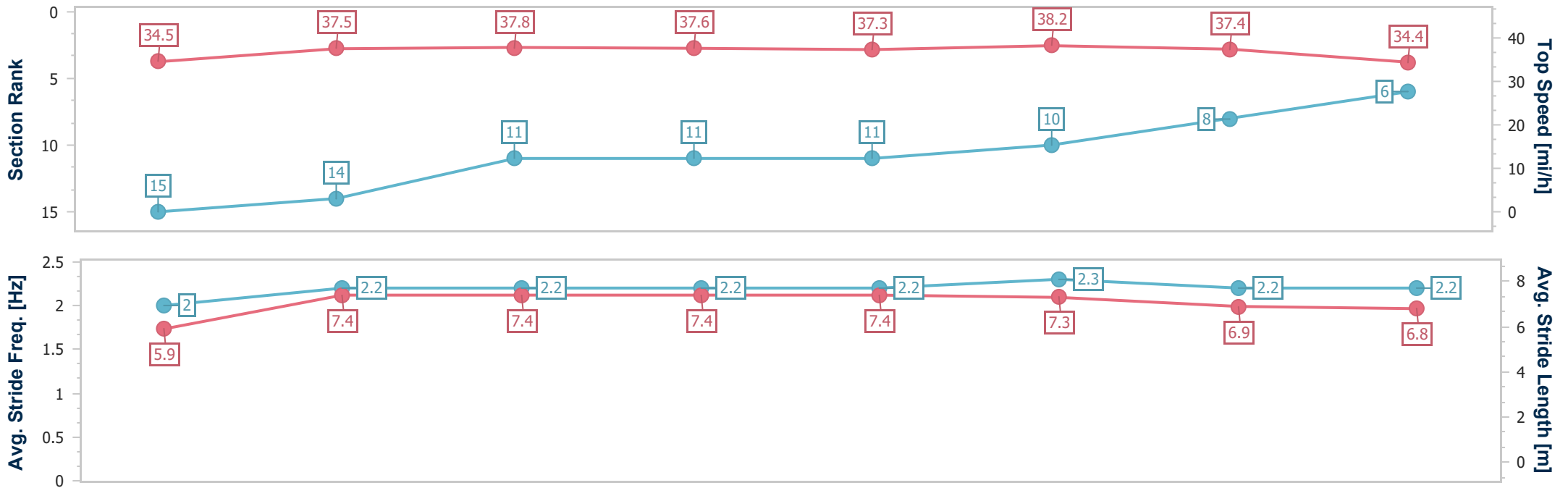

- [] Ranking at each section and finish
- .-.- No data available at this section
- NA No data available

Horse Name	Repertoire
Final Rank	7
Fastest Section Time (Section)	0:12.20 (2fur)
Top Speed [mi/h] (Section)	37.6 (2fur)
Race State	Finished

Royal Ascot Trials Day

Race 1: Howden Manny Mercer Apprentice Handicap (Str) - 1M 

03 May 2023 - 13:31

Track Rating: Good, Weather: Fine, Rail Position: True

Distance To Go	7fur	6fur	5fur	4fur	3fur	2fur	1fur	Finish					
Section Times	0:16.44 [13] (0:16.44)	0:28.76 [13] (0:12.32)	0:41.07 [15] (0:12.31)	0:53.65 [15] (0:12.58)	1:06.02 [15] (0:12.37)	1:18.22 [14] (0:12.20)	1:30.91 [10] (0:12.69)	1:44.15 (0:13.24)					
Average Speed [mi/h]	27.5	36.4	36.8	35.7	36.3	36.9	35.4	33.7					
Top Speed [mi/h]	34.3	37.0	37.2	36.9	36.8	37.6	37.2	35.8					
Avg. Dist. to Rail [m]	13.5	16.4	17.0	17.6	15.3	13.3	10.6	8.3					
Avg. Stride Freq. [Hz]	2.1	2.2	2.2	2.2	2.2	2.3	2.3	2.2					
Avg. Stride Length [m]	5.9	7.2	7.4	7.3	7.3	7.3	7.0	6.9					

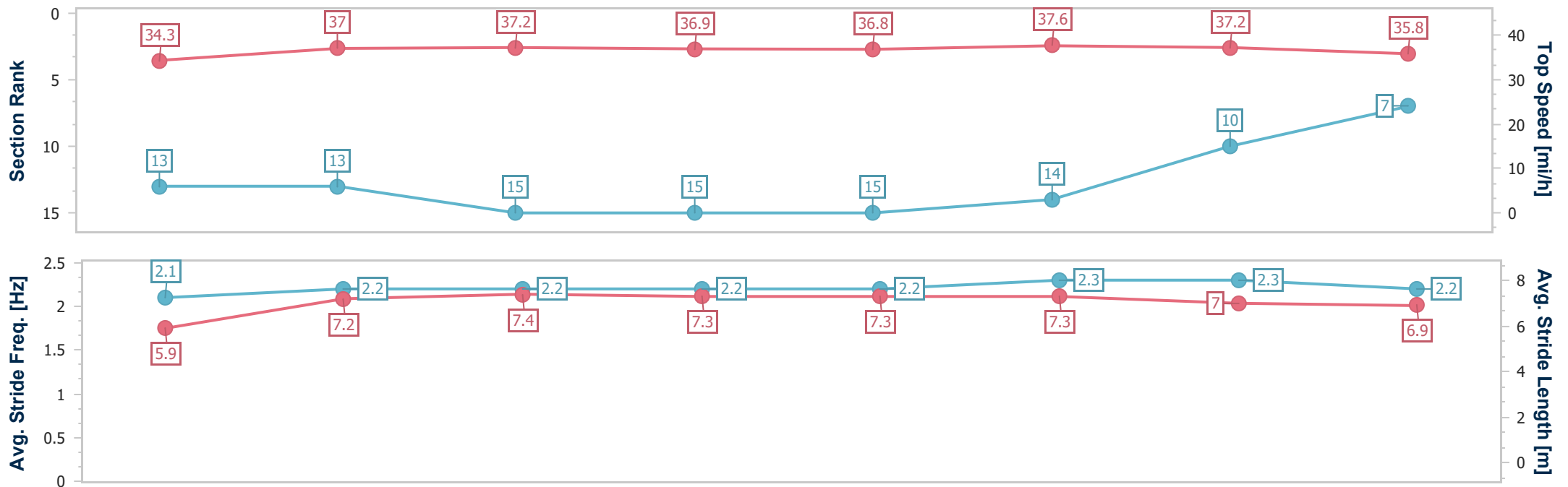

- [] Ranking at each section and finish
- .-.- No data available at this section
- NA No data available



Horse Name	Fantasy Believer
Final Rank	8
Fastest Section Time (Section)	0:12.19 (5fur)
Top Speed [mi/h] (Section)	37.9 (2fur)
Race State	Finished

Royal Ascot Trials Day

Race 1: Howden Manny Mercer Apprentice Handicap (Str) - 1M 

03 May 2023 - 13:31

Track Rating: Good, Weather: Fine, Rail Position: True

Distance To Go	7fur	6fur	5fur	4fur	3fur	2fur	1fur	Finish					
Section Times	0:16.16 [9] (0:16.16)	0:28.45 [9] (0:12.29)	0:40.64 [8] (0:12.19)	0:52.95 [7] (0:12.31)	1:05.23 [7] (0:12.28)	1:17.43 [9] (0:12.20)	1:30.68 [9] (0:13.25)	1:44.18 (0:13.50)					
Average Speed [mi/h]	27.9	36.8	37.0	36.5	36.6	37.1	33.9	33.0					
Top Speed [mi/h]	33.8	37.2	37.5	37.3	37.1	37.9	37.1	34.1					
Avg. Dist. to Rail [m]	18.2	18.5	19.1	19.6	19.0	18.1	16.5	15.2					
Avg. Stride Freq. [Hz]	2.2	2.4	2.3	2.3	2.3	2.3	2.3	2.2					
Avg. Stride Length [m]	5.6	6.9	7.1	7.1	7.1	7.1	6.6	6.7					

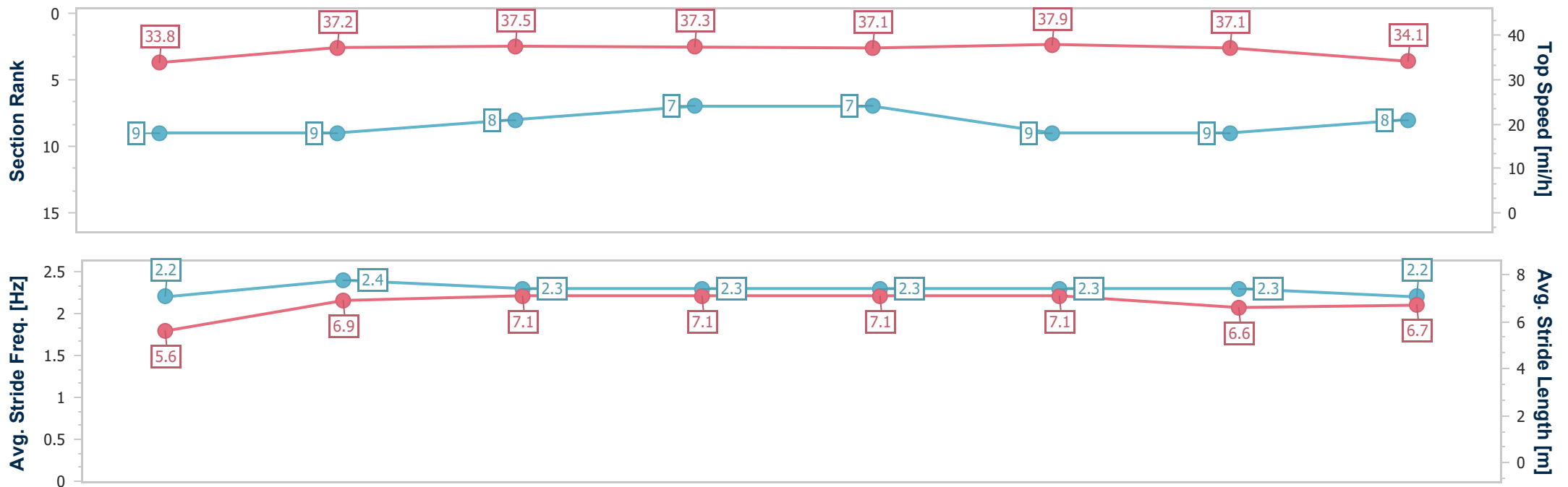

- [] Ranking at each section and finish
- .-.- No data available at this section
- NA No data available



Horse Name	Raising Sand
Final Rank	9
Fastest Section Time (Section)	0:12.14 (5fur)
Top Speed [mi/h] (Section)	37.9 (2fur)
Race State	Finished

Royal Ascot Trials Day
Race 1: Howden Manny Mercer Apprentice Handicap (Str) - 1M 
03 May 2023 - 13:31
Track Rating: Good, Weather: Fine, Rail Position: True

Distance To Go	7fur	6fur	5fur	4fur	3fur	2fur	1fur	Finish					
Section Times	0:15.85 [4] (0:15.85)	0:28.07 [4] (0:12.22)	0:40.21 [3] (0:12.14)	0:52.57 [3] (0:12.36)	1:04.79 [3] (0:12.22)	1:17.10 [4] (0:12.31)	1:30.39 [6] (0:13.29)	1:44.40 (0:14.01)					
Average Speed [mi/h]	28.4	36.7	37.0	36.5	36.7	36.4	33.9	31.8					
Top Speed [mi/h]	34.3	37.4	37.7	37.5	37.3	37.9	36.8	33.9					
Avg. Dist. to Rail [m]	13.2	17.0	18.1	18.9	18.4	17.8	15.3	13.6					
Avg. Stride Freq. [Hz]	2.0	2.2	2.2	2.2	2.2	2.3	2.3	2.2					
Avg. Stride Length [m]	6.3	7.4	7.4	7.3	7.3	7.2	6.7	6.4					

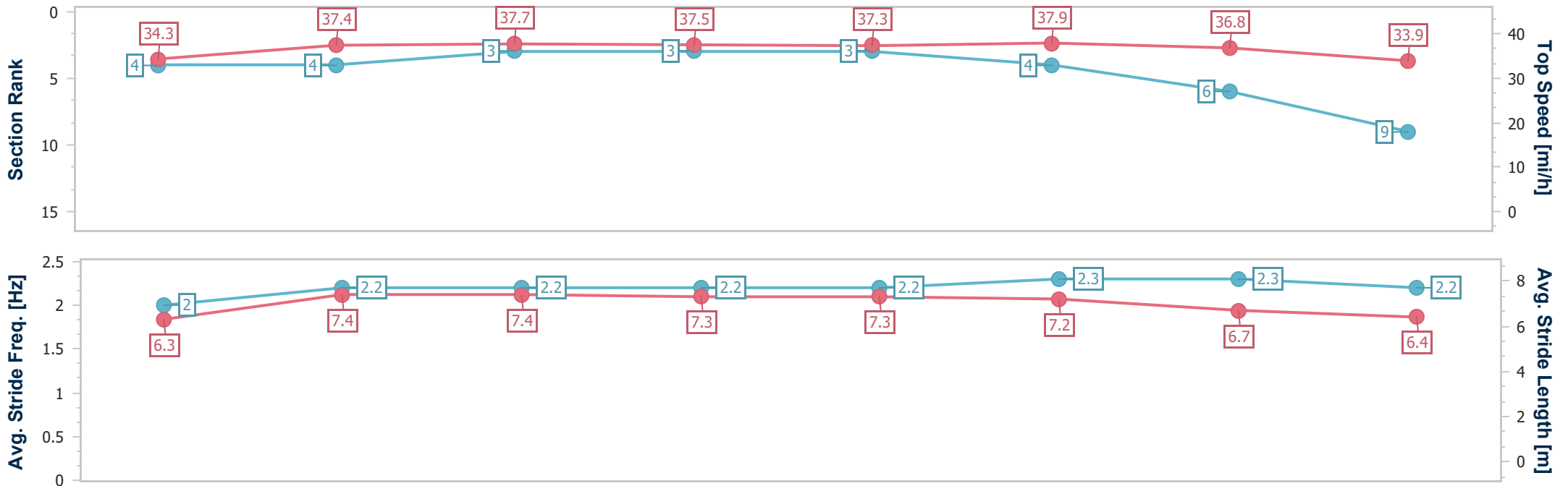

- [] Ranking at each section and finish
- .-.- No data available at this section
- NA No data available

Horse Name	Devasboy
Final Rank	10
Fastest Section Time (Section)	0:12.17 (2fur)
Top Speed [mi/h] (Section)	37.9 (2fur)
Race State	Finished

Royal Ascot Trials Day
Race 1: Howden Manny Mercer Apprentice Handicap (Str) - 1M 
03 May 2023 - 13:31
Track Rating: Good, Weather: Fine, Rail Position: True

Distance To Go	7fur	6fur	5fur	4fur	3fur	2fur	1fur	Finish					
Section Times	0:16.32 [10] (0:16.32)	0:28.64 [11] (0:12.32)	0:40.98 [13] (0:12.34)	0:53.46 [14] (0:12.48)	1:05.76 [13] (0:12.30)	1:17.93 [13] (0:12.17)	1:30.93 [11] (0:13.00)	1:44.59 (0:13.66)					
Average Speed [mi/h]	27.7	36.5	36.5	36.0	36.6	37.1	34.6	32.6					
Top Speed [mi/h]	34.2	36.9	37.2	36.9	37.1	37.9	37.2	34.7					
Avg. Dist. to Rail [m]	21.7	20.1	20.6	21.4	21.3	22.8	24.2	22.0					
Avg. Stride Freq. [Hz]	2.3	2.5	2.4	2.4	2.4	2.4	2.4	2.3					
Avg. Stride Length [m]	5.5	6.6	6.7	6.6	6.7	6.8	6.4	6.2					

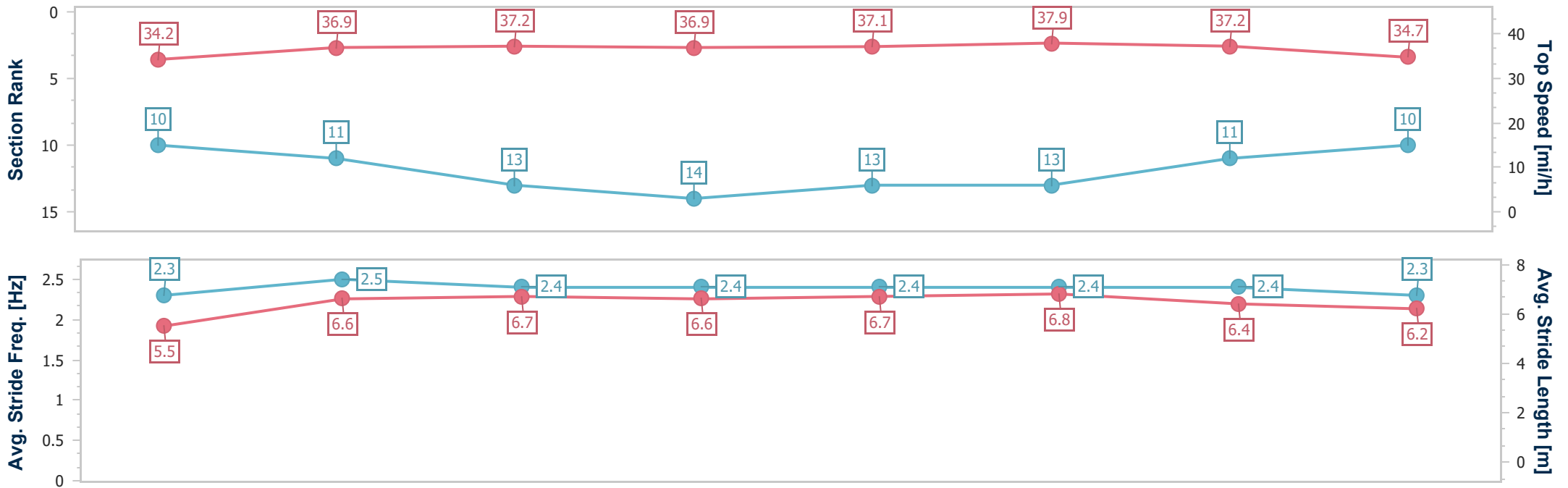

- [] Ranking at each section and finish
- .-.- No data available at this section
- NA No data available

Horse Name	Two Tempting
Final Rank	11
Fastest Section Time (Section)	0:12.12 (6fur)
Top Speed [mi/h] (Section)	37.7 (5fur)
Race State	Finished

Royal Ascot Trials Day
 Race 1: Howden Manny Mercer Apprentice Handicap (Str) - 1M 
 03 May 2023 - 13:31
 Track Rating: Good, Weather: Fine, Rail Position: True

Distance To Go	7fur	6fur	5fur	4fur	3fur	2fur	1fur	Finish					
Section Times	0:15.72 [1] (0:15.72)	0:27.84 [1] (0:12.12)	0:40.05 [1] (0:12.21)	0:52.41 [1] (0:12.36)	1:04.70 [1] (0:12.29)	1:17.03 [1] (0:12.33)	1:30.50 [7] (0:13.47)	1:44.97 (0:14.47)					
Average Speed [mi/h]	28.8	37.1	36.8	36.4	36.7	36.6	33.4	30.7					
Top Speed [mi/h]	34.5	37.7	37.7	37.2	37.2	37.7	36.7	33.3					
Avg. Dist. to Rail [m]	16.4	17.7	18.6	19.5	19.5	19.2	18.2	16.9					
Avg. Stride Freq. [Hz]	2.1	2.4	2.4	2.4	2.4	2.4	2.4	2.3					
Avg. Stride Length [m]	6.0	7.0	6.9	6.9	6.9	6.8	6.3	6.1					

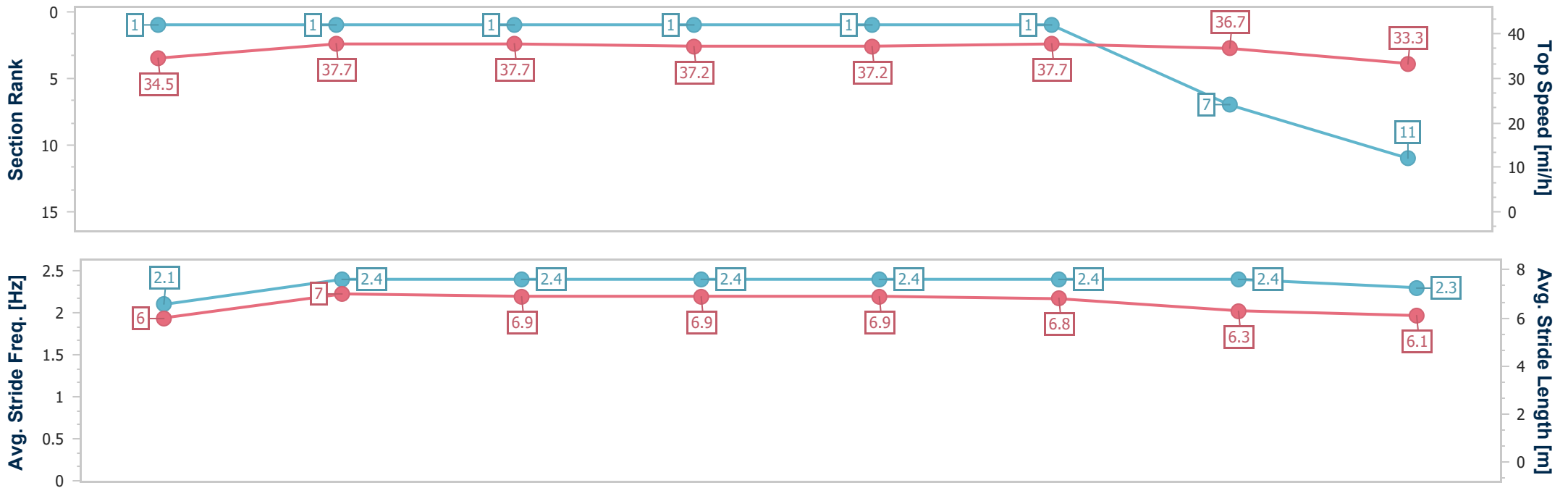

- [] Ranking at each section and finish
- .-.- No data available at this section
- NA No data available

Horse Name	Bear Force One
Final Rank	12
Fastest Section Time (Section)	0:12.11 (6fur)
Top Speed [mi/h] (Section)	37.6 (5fur)
Race State	Finished

Royal Ascot Trials Day
 Race 1: Howden Manny Mercer Apprentice Handicap (Str) - 1M 
 03 May 2023 - 13:31
 Track Rating: Good, Weather: Fine, Rail Position: True

Distance To Go	7fur	6fur	5fur	4fur	3fur	2fur	1fur	Finish					
Section Times	0:15.76 [3] (0:15.76)	0:27.87 [2] (0:12.11)	0:40.08 [2] (0:12.21)	0:52.44 [2] (0:12.36)	1:04.74 [2] (0:12.30)	1:17.25 [5] (0:12.51)	1:31.08 [12] (0:13.83)	1:45.94 (0:14.86)					
Average Speed [mi/h]	28.5	36.8	36.4	36.4	36.4	35.9	32.6	30.0					
Top Speed [mi/h]	34.3	37.5	37.6	37.3	37.2	37.5	36.0	32.6					
Avg. Dist. to Rail [m]	20.9	19.7	20.4	20.8	20.6	20.6	19.5	18.6					
Avg. Stride Freq. [Hz]	2.2	2.3	2.3	2.3	2.3	2.3	2.2	2.1					
Avg. Stride Length [m]	5.8	7.0	7.0	7.0	7.0	6.9	6.6	6.3					

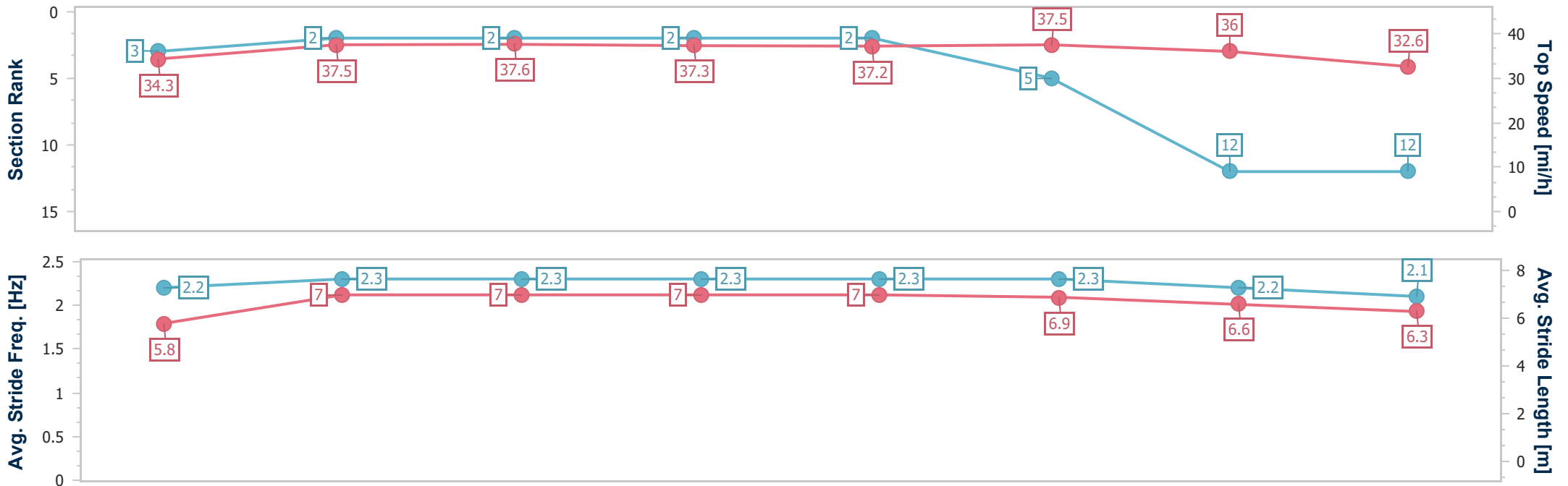

- [] Ranking at each section and finish
- .-.- No data available at this section
- NA No data available

Horse Name	Diffident Spirit
Final Rank	13
Fastest Section Time (Section)	0:12.23 (5fur)
Top Speed [mi/h] (Section)	37.7 (2fur)
Race State	Finished

Royal Ascot Trials Day
Race 1: Howden Manny Mercer Apprentice Handicap (Str) - 1M 
03 May 2023 - 13:31
Track Rating: Good, Weather: Fine, Rail Position: True

Distance To Go	7fur	6fur	5fur	4fur	3fur	2fur	1fur	Finish					
Section Times	0:16.38 [11] (0:16.38)	0:28.65 [12] (0:12.27)	0:40.88 [12] (0:12.23)	0:53.22 [10] (0:12.34)	1:05.48 [12] (0:12.26)	1:17.85 [12] (0:12.37)	1:31.66 [14] (0:13.81)	1:45.97 (0:14.31)					
Average Speed [mi/h]	27.5	36.7	36.9	36.5	36.7	36.4	32.6	31.2					
Top Speed [mi/h]	33.9	37.1	37.4	37.2	37.2	37.7	36.5	32.6					
Avg. Dist. to Rail [m]	18.7	18.6	19.0	19.5	19.3	19.4	18.2	16.1					
Avg. Stride Freq. [Hz]	2.2	2.4	2.4	2.4	2.4	2.4	2.3	2.3					
Avg. Stride Length [m]	5.6	6.8	6.8	6.8	6.8	6.7	6.2	6.2					

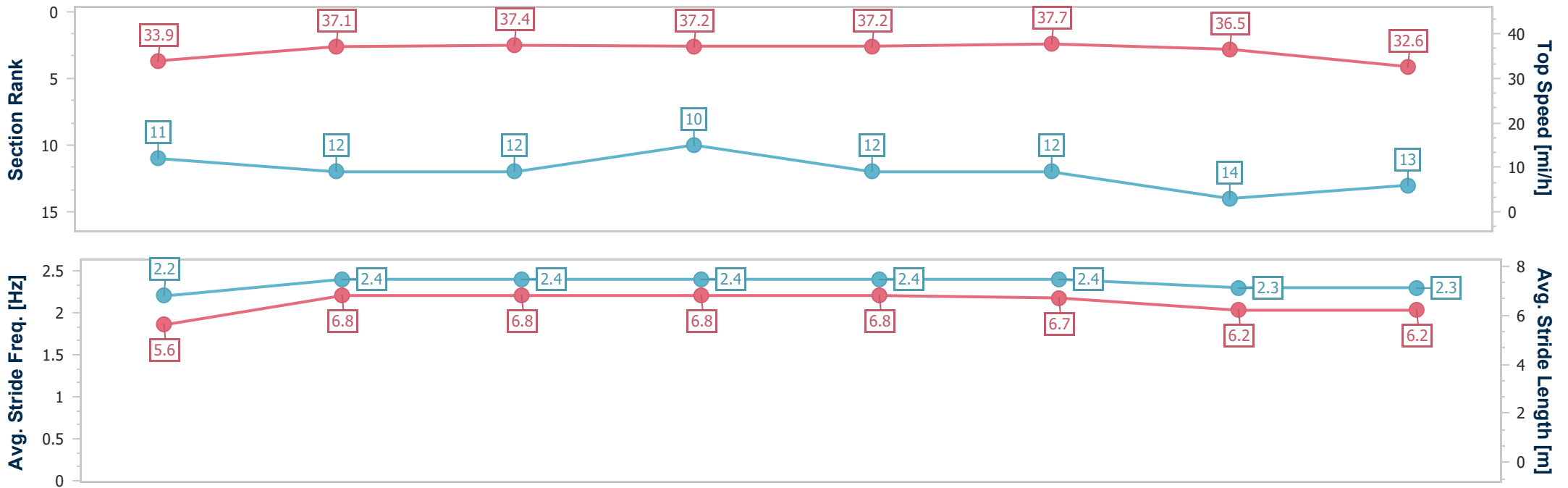

- [] Ranking at each section and finish
- .-.- No data available at this section
- NA No data available

Horse Name	Sagano
Final Rank	14
Fastest Section Time (Section)	0:12.33 (5fur)
Top Speed [mi/h] (Section)	37.2 (5fur)
Race State	Finished

Royal Ascot Trials Day

Race 1: Howden Manny Mercer Apprentice Handicap (Str) - 1M 

03 May 2023 - 13:31

Track Rating: Good, Weather: Fine, Rail Position: True

Distance To Go	7fur	6fur	5fur	4fur	3fur	2fur	1fur	Finish					
Section Times	0:16.05 [6] (0:16.05)	0:28.44 [8] (0:12.39)	0:40.77 [10] (0:12.33)	0:53.32 [13] (0:12.55)	1:05.95 [14] (0:12.63)	1:18.45 [15] (0:12.50)	1:31.93 [15] (0:13.48)	1:46.24 (0:14.31)					
Average Speed [mi/h]	28.2	36.4	36.4	35.5	35.6	36.0	33.4	31.2					
Top Speed [mi/h]	34.1	36.9	37.2	37.0	36.2	37.0	36.2	33.6					
Avg. Dist. to Rail [m]	15.4	17.9	18.4	19.2	17.9	16.0	13.2	8.0					
Avg. Stride Freq. [Hz]	2.1	2.2	2.2	2.3	2.2	2.3	2.2	2.2					
Avg. Stride Length [m]	6.1	7.2	7.3	7.1	7.1	7.1	6.7	6.4					

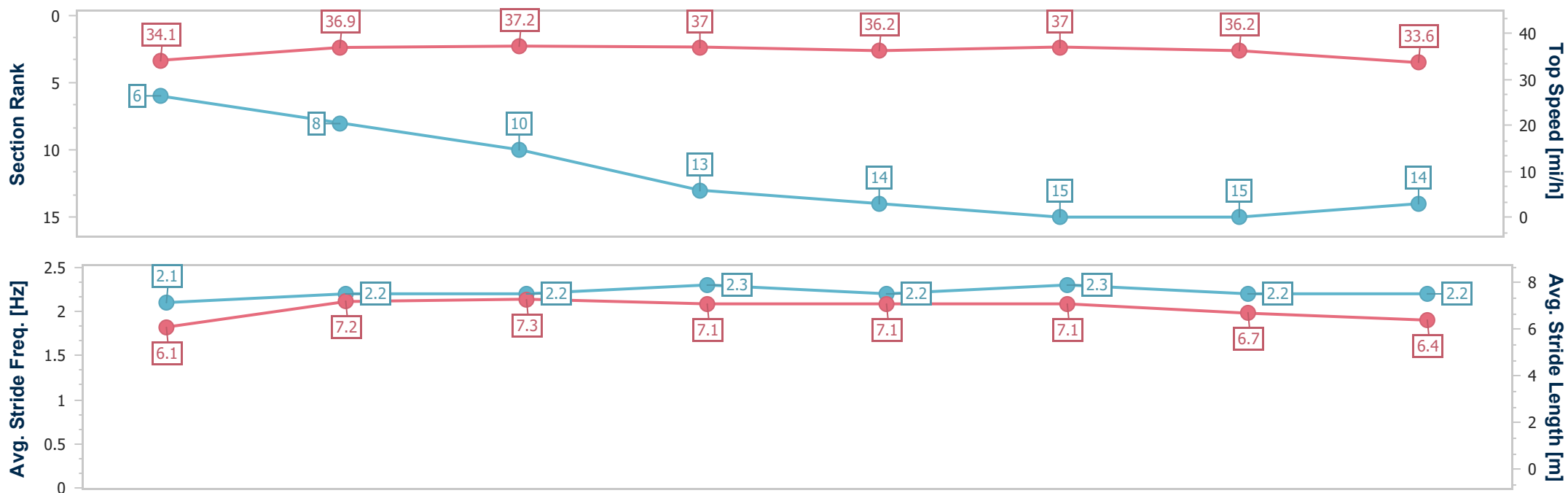

- [] Ranking at each section and finish
- .-.- No data available at this section
- NA No data available



Horse Name	Al Marmar
Final Rank	15
Fastest Section Time (Section)	0:12.14 (5fur)
Top Speed [mi/h] (Section)	37.9 (2fur)
Race State	Finished

Royal Ascot Trials Day
Race 1: Howden Manny Mercer Apprentice Handicap (Str) - 1M 
03 May 2023 - 13:31
Track Rating: Good, Weather: Fine, Rail Position: True

Distance To Go	7fur	6fur	5fur	4fur	3fur	2fur	1fur	Finish					
Section Times	0:16.38 [11] (0:16.38)	0:28.59 [10] (0:12.21)	0:40.73 [9] (0:12.14)	0:53.10 [9] (0:12.37)	1:05.34 [10] (0:12.24)	1:17.78 [11] (0:12.44)	1:31.60 [13] (0:13.82)	1:46.34 (0:14.74)					
Average Speed [mi/h]	27.6	36.8	37.2	36.4	36.8	36.3	32.5	30.4					
Top Speed [mi/h]	34.6	37.3	37.8	37.4	37.2	37.9	36.2	32.6					
Avg. Dist. to Rail [m]	11.0	15.6	16.8	17.7	17.3	17.3	16.1	14.9					
Avg. Stride Freq. [Hz]	2.1	2.3	2.3	2.3	2.3	2.4	2.3	2.2					
Avg. Stride Length [m]	5.9	7.2	7.2	7.1	7.1	6.9	6.4	6.2					

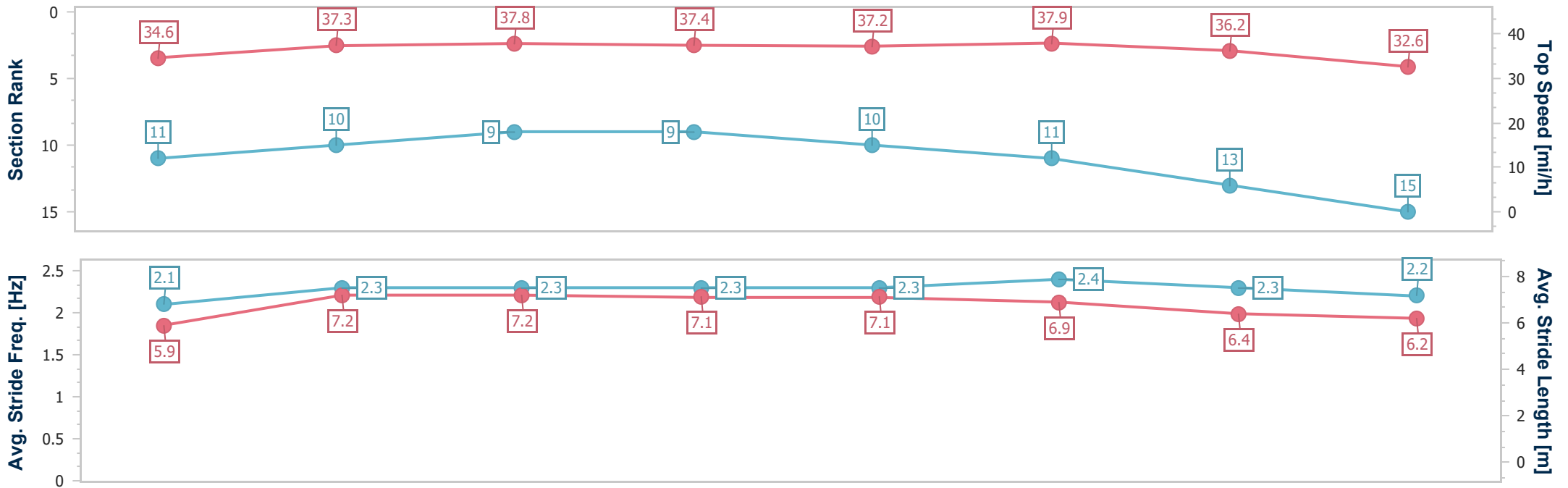

- [] Ranking at each section and finish
- .-.- No data available at this section
- NA No data available